

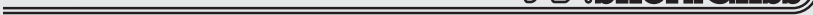





Decorative Curtain Poles

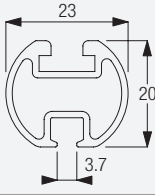

Application Chart

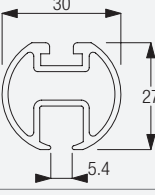
Operation	Dimensions		Application		Profile		Features / Options			Fitting Options		Fitting Surfaces		System			
	max.	kg max.	Single Stack	Pair Stack	Profile Number	Dimensions in mm	Gliding Channel (mm)	Min. Bending Radius (mm)	Various Finials available	Intermediate Pulley available	Wave Glider Cord	Ceiling Fix	Wall Fix		Wood	Concrete	Suspended Ceiling
					1003		3.7	150	●			●	●	●	●	●	1003 M Mini Metropole
					6103		5.4	300	●		●	●	●	●	●	●	6130 M Metropole
	6 m	14	●	●	1003		5.4	450	●	●	●	●	●	●	●	●	6120 M Metropole

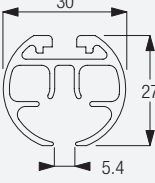

Hand Operated Curtain Pole System

Silent Gliss® 1003M Mini Metropole

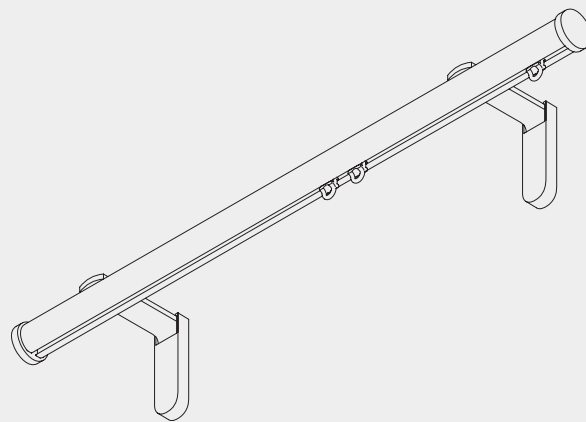

Product Information

- Hand operated curtain poles for domestic and contract applications.
- Ideal for bay windows.
- For light to medium weight curtains.
- Made to measure.
- Profile length 6m (chrome effect 4m).
- Four different finishes - black, silver, chrome effect, gunmetal and white.
- Range of decorative finial and midial designs in different styles and colours based around 6 moods - mono, teatro, primavera, studio, overture and metropolitan.
- Midial designs can also be used with holdback arms to create an attractive addition.
- Wall fix only with standard or 'ultra' brackets.
- Unlike other poles, 1003 can be bent to a small radius for bay windows etc.



1003M

Profile and Bending Information

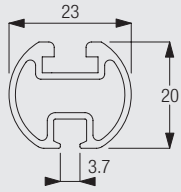

1003



Min. radius 15 cm

Design Options

Finials

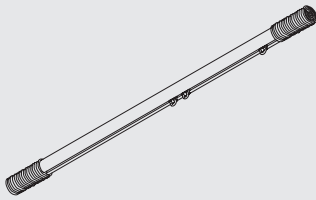

Finials are decorative elements that fit at the end of the pole.

Please refer to the specific Metropole brochure for more detailed and colour descriptions.

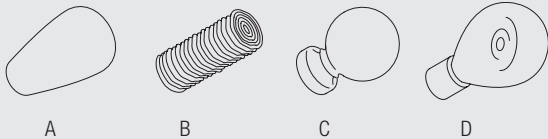

- A: Paddle
- B: Pepito
- C: Ball
- D: Hepworth

Without finial, endcaps with matching colour of the pole will be applied. Please refer to the specific Metropole brochure for more detailed and colour descriptions.

Medials



1003M

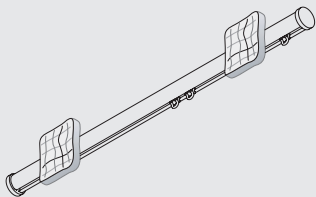

Medials are a curtain pole decoration projected in front of the pole. They cannot be used for ceiling fix applications.

Please refer to the specific Metropole brochure for more detailed and colour descriptions.



Medial with 55mm side length "Nugget", available in grey, amber or brown glass.

Holdbacks

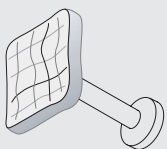

Nugget medials are available as holdbacks.

Please refer to the specific Metropole brochure for more detailed and colour descriptions.

Combine Metropole with Roman Blinds

All of the Metropole systems can be used to create a winning new look - the METROPOLE ROMAN (Silent Gliss Roman Blind system 2010). Using a new technique either tab-top or flat-heading Roman blinds are hung from the Metropole and operated by a patented cord-lock system.

Fitting Information

Bracket Positioning when using standard brackets 3134-3136 or Ultra brackets 6133/6134



Fitting of track to brackets

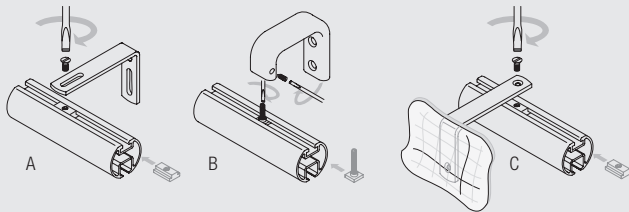

A: Using brackets 3134 - 3136
B: Using brackets 6133 and 6134

Fitting Options

Wall fix with brackets 3134/3135/3136 and bracket cover 3133

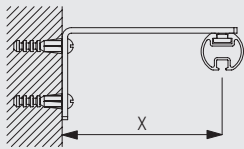

	X
3134	52mm
3135	72mm
3136	92mm

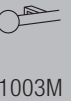
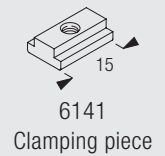
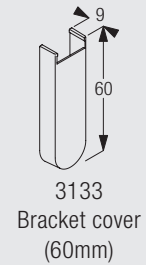
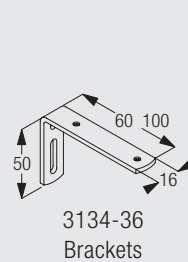

Wall fix with ultra brackets 6133 and 6134

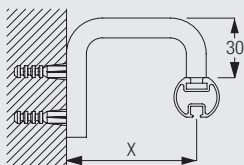

	X
6133	65mm
6134	115mm

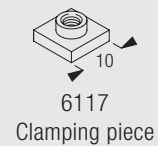
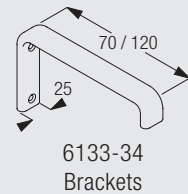

Ceiling fix with support 6138P

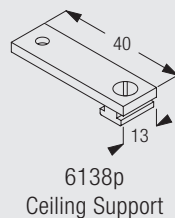
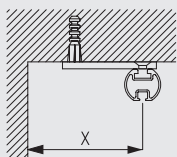

Standard Accessories

0706 End cover



3070 End stop



3133 Bracket cover (60mm)



3134 Bracket (60mm)

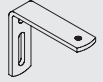

3533 Glider



3534 Glider 3533 in strip form



Optional Accessories

0732 Hexagonal Nut



0733 M6 Washer for Midial



0797a Medial bracket



3135 Bracket (80mm)

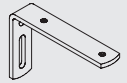

3136 Bracket (100mm)

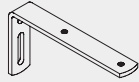

3582 Hook



6133 Bracket (70mm)



6134 Bracket (120mm)



6138p Ceiling Support



1003M

Hand Operated Curtain Pole System

Silent Gliss® 6100M Metroflat

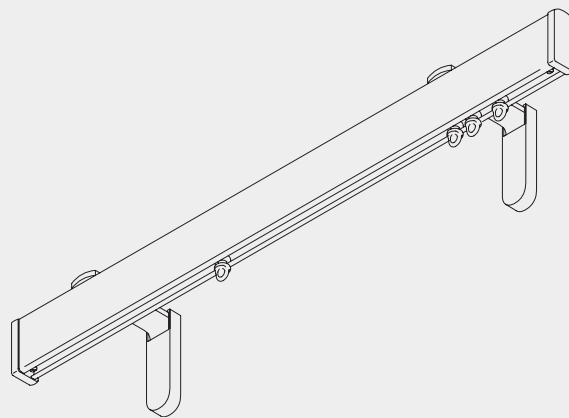

Product Information

- Hand operated system for domestic and contract applications.
- Attractive contemporary appearance for modern interiors.
- Can be bent to a small radius for bay windows.
- Available in 4 finishes - chrome effect, silver, black and gunmetal.
- Accessorised with matching endcaps and co-ordinated or matching brackets / bracket covers.
- Easy fitting to wall or ceiling with choice of standard or 'ultra' brackets.
- For medium to heavy curtains.



6100M

Profile and Bending Information

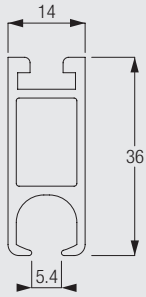

6101



Min. radius 15 cm

Fitting Information

Bracket Positioning when using standard brackets 3134-3136 or Ultra brackets 6133/6134

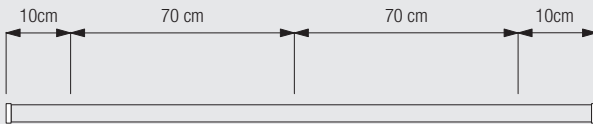

Fitting of track to brackets

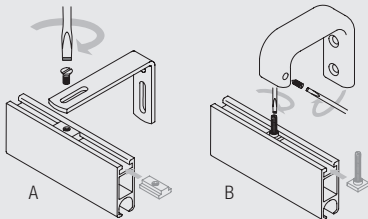

A: Using brackets 3134 - 3136
B: Using brackets 6133 and 6134



6100M

Fitting Options

Wall fix with brackets 3134/3135/3136 and bracket cover 3133

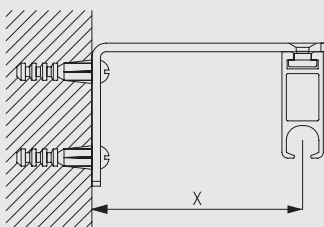

	X
3134	52mm
3135	72mm
3136	92mm

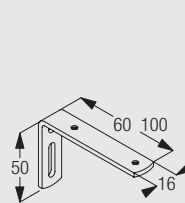

3134-36
Brackets

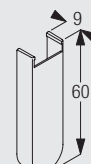

3133
Bracket cover
(60mm)

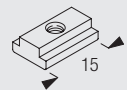

6141
Clamping piece

Wall fix with ultra brackets 6133 and 6134

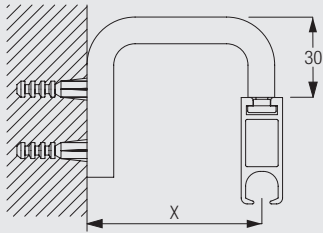

	X
6133	65mm
6134	105mm

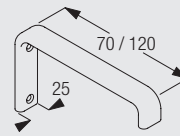

6133-34
Brackets

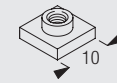

6117
Clamping piece

Ceiling fix with support 6138P

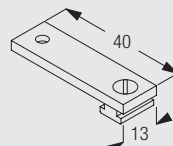
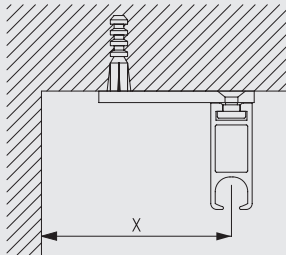

6138p
Ceiling Support

Standard Accessories

3133 Bracket cover (60mm)



3134 Bracket (60mm)

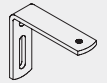

6065 Eye endstop



6141 Clamping piece

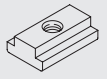

6143 Glider 6144 in strip form



6611 Endcover



6100M

Optional Accessories

0732 Hexagonal Nut



0733 M6 Washer for Midial



0797a Medial bracket



3135 Bracket (80mm)

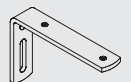

3136 Bracket (100mm)

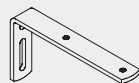

3582 Hook



6117 Clamping piece



6133 Bracket (70mm)



6134 Bracket (120mm)



6138p Ceiling Support

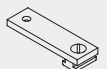

6283 Roller





6100M

Cord Operated Curtain Pole System

Silent Gliss® 6120M Metropole

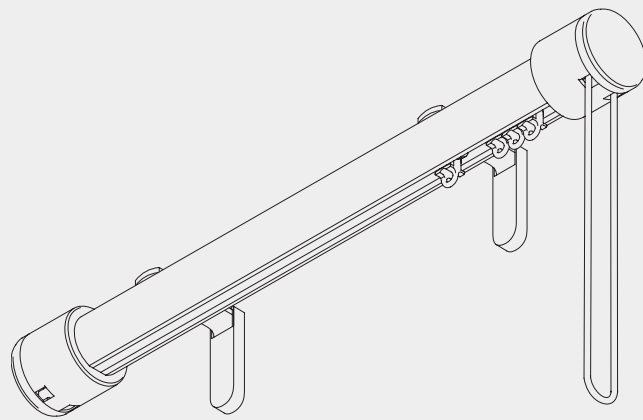

Product Information

- Cord operated system for domestic and contract applications.
- 6120 can be bent to a small radius for bay windows etc..
- For light to medium weight curtains.
- Made to measure.
- Profile length 6m (chrome effect in 4m).
- Choice of 13 different finishes - chrome effect, gunmetal, anodised silver, black, white, diva gold, classic gold and wood effects; wenge, mahogany, cherry wood, honey maple, teak and beech.
- Easily fitted to wall or ceiling with choice of standard or 'ultra' brackets (for chrome effect, gunmetal, white and black only).
- Optional designer cord weights.
- A limited range of finials can be used as well as midials.



6120M

Profile and Bending Information

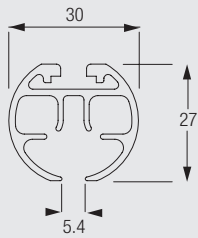

6106



45 cm

System Dimensions

Max. Curtain Weights

	1 m	2 m	3 m	4 m	5 m	6 m
	10	9	9	9	8	8
	11	11	10	10	9	9
	8	7	7	7	6	6
	9	8	8	8	7	7
	5	4	4	4	3	3
	6	5	5	5	4	4
	4	3	3	3	2	2
	5	4	4	4	3	3

(kg max.)



6120M

Design Options

Finials

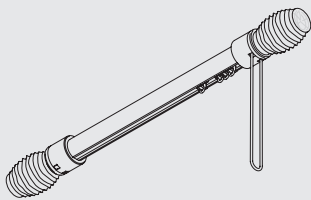

Finials are decorative elements that fit on at the end of the pole. Metropole corded is available with the finial option of ball end, cross-grain finials, or any of the woodend finials.

Please refer to the specific Metropole brochure for more detailed and colour descriptions.

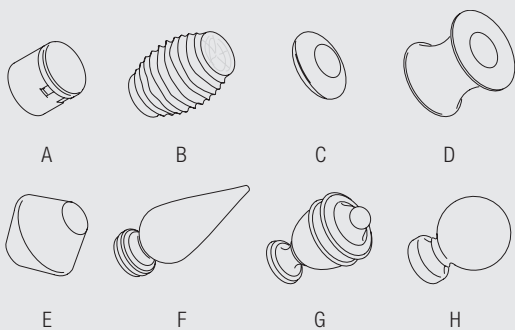

A: Without finials, endcaps with matching colour of the pole will be applied.

B: Ball End

C: Cross-grain

D: Woodend (Alpha, Beta, Gamma)

Medials

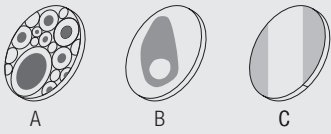
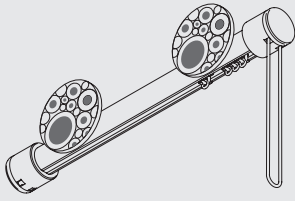

Medials are a certain pole decoration projected in front of the pole. They cannot be used for ceiling fix applications.

Please refer to the specific Metropole brochure for more detailed and colour descriptions.

Medials with 90 mm diameter

- A: Bamboo disc
- B: Mother of Pearl Disc
- C: Veneer Disc

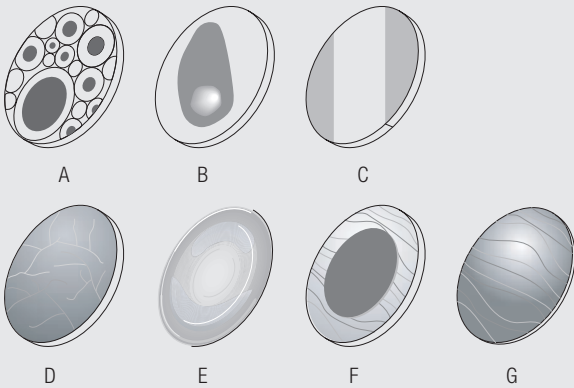

Medials with 100 mm diameter

- A: Crackle (fuchsia, lilac)
- B: Discus Glas (red, white amber, purple, lilac)
- C: Wood/Leather (oak, walnut)
- D: Wood (oak, walnut)

Holdbacks

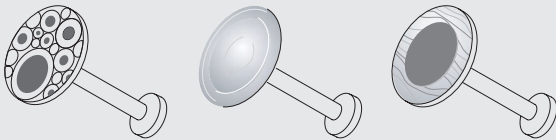

Medial designs can be used on matching holdback arms.

Please refer to the specific Metropole brochure for more detailed and colour descriptions.

Wave curtain heading system

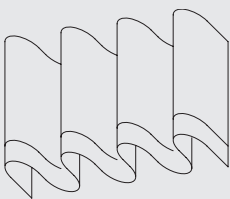

The Wave is an exciting new contemporary curtain heading system which allows curtains to hang in a continuous wave which is smooth, simple and elegant.

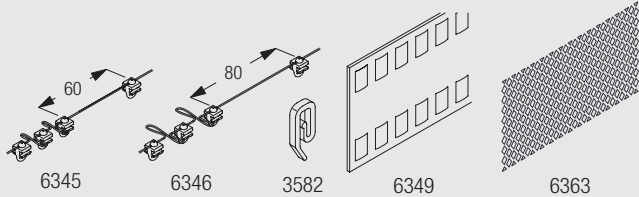

The Wave components are:

- 6345 Glider Cord 60mm
- 6346 Glider Cord 80mm
- 3582 Hook
- 6349 Curtain tape
- 6363 Iron tape



6120M

Fitting Information

Bracket Positioning

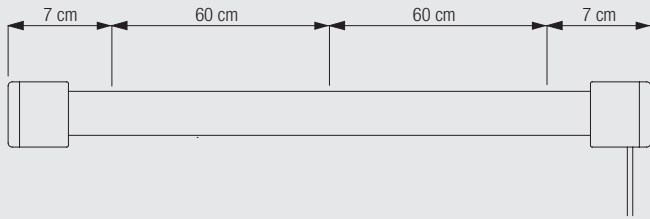

The fixing points are for both available brackets identical.

For the standard bracket 3134-3136 or the ultra brackets 6133 and 6134

Fitting of track to brackets

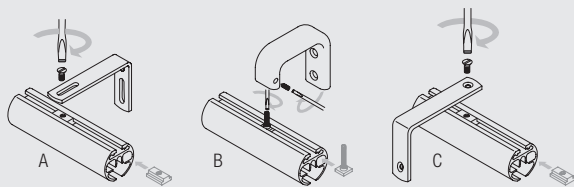

A: Using brackets 3134 - 3136

B: Using brackets 6133 and 6134

Fitting Options

Wall fix with brackets 3134/3135/3136 and bracket cover 3133

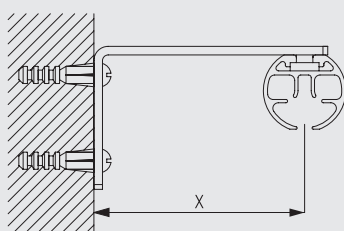

	X
3134	52mm
3135	72mm
3136	92mm

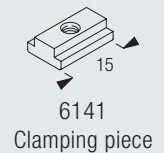
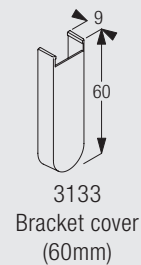
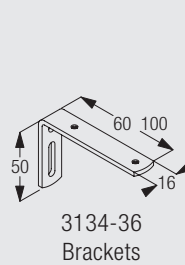

Wall fix with ultra brackets 6133 and 6134

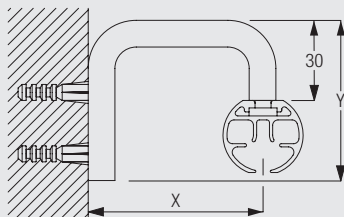

	X
6133	65mm
6134	115mm

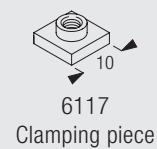
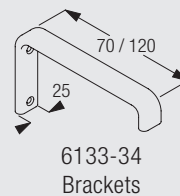

Ceiling fix with support 6138P

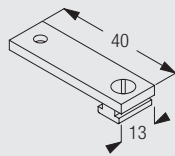
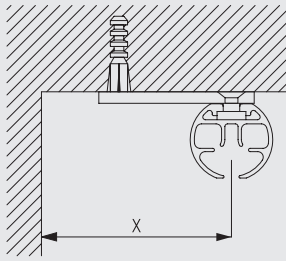

6138p
Ceiling Support

Standard Accessories

Single Parts

3091	Cord		3133	Bracket cover (60mm)	
3134	Bracket (60mm)		3287	Support right comb.	
6063	Overlap arm		6065	Eye endstop	
6106	Profile		6113	Case	
6114	Cover (ø 40mm)		6143	Glider 6144 in strip form	
6354	Pilot runner				









6120M

Sets

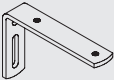
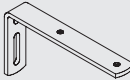

6119	Guide returns, containing		3287	Support right comb.	2	
			6113	Case	2	
			6114	Cover (ø 40mm)	2	
			6354	Pilot runner	2	

Optional Accessories

Single Parts

0518	Cord weight		0519	Cord Weight	
3135	Bracket (80mm)		3136	Bracket (100mm)	
6133	Bracket (70mm)		6134	Bracket (120mm)	
6138p	Ceiling Support		6283	Roller	

Sets

6165	Intermediate pulley, containing		6103	Profile	1	
			6164	Clamping piece	1	
			6169	Holder	1	

Useful Measures

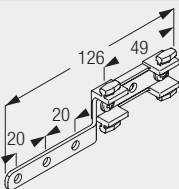
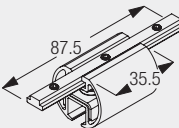
6120M	6063	Overlap arm		6165	Bracket	
-------	------	-------------	---	------	---------	---

Hand Operated Curtain Pole System

Silent Gliss® 6130M Metropole

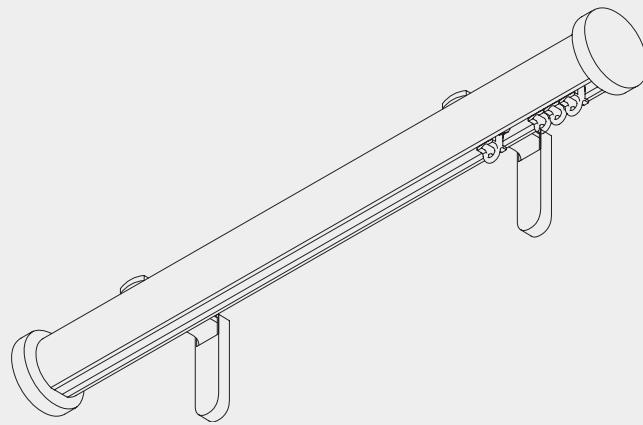

Product Information

- Hand operated system for domestic and contract applications.
- Attractive contemporary appearance for modern interiors.
- Unlike other poles, 6130 can be bent to a small radius for bay windows.
- Choice of 13 different finishes - gunmetal, black, white, diva gold, classic gold, chrome effect, anodised silver and wood effects; wenge, mahogany, cherry wood, teak, honey maple and beech.
- Metropole is available in six colour co-ordinated moods; mono, primavera, studio, overture, teatro and metropolitan.
- Poles, finials and midials can be mix and match purchased from these moods.
- Accessorised with matching end caps and co-ordinated or matching brackets/bracket covers.
- A wide range of finials is available for the 6130 hand operated system.
- A range of midials - a decoration projected in front of the pole - is available for Metropole. Midials cannot be used for ceiling fix applications. All midials can be used as holdbacks.
- Easy fitting to wall or ceiling with a choice of standard or 'ultra' brackets (for black, gunmetal, chrome effect, anodised silver and white only).
- For medium to heavy curtains.
- Can also be used with Roman Blinds - see Metropole Roman system 2010.



6130M

Profile and Bending Information

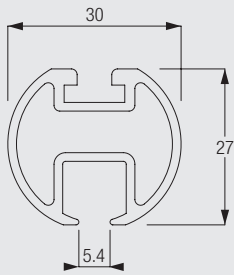

6103



Min. radius 30 cm

Design Options

Finials

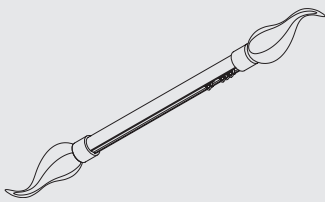

Finials are decorative elements that fit on at the end of the pole.

Please refer to the specific Metropole brochure for more detailed and colour descriptions.

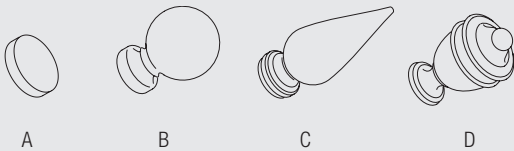

A: Without finials, endcaps with matching colour of the pole will be applied.

B: Ball End
C: Spear End
D: Urn End

6130M

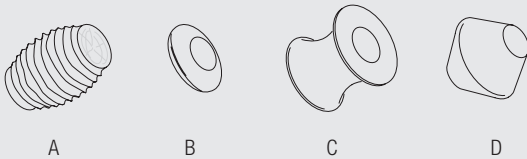

A: Cross Grain
B: Woodend Alpha
C: Woodend Beta
D: Woodend Gamma

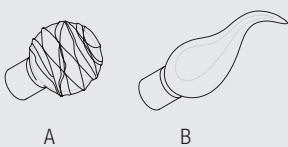

A: Trail Glass
B: Iris Clear

Medials

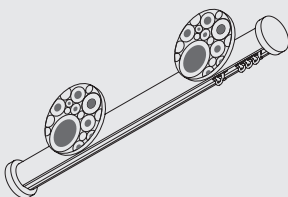

Medials are a certain pole decoration projected in front of the pole. They cannot be used for ceiling fix applications.

Please refer to the specific Metropole brochure for more detailed and colour descriptions.

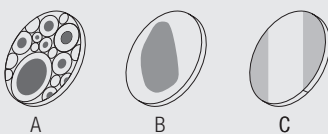

Medials with 90 mm diameter

A: Bamboo disc
B: Mother of Pearl Disc
C: Veener Disc

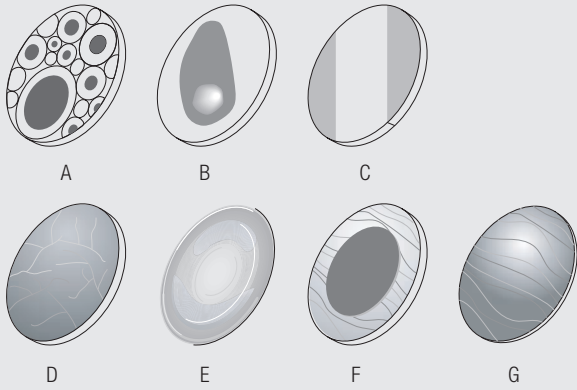

Medials with 100 mm diameter

- A: Crackle (fuchsia, lilac)
- B: Discus Glas (red, white amber, purple, lilac)
- C: Wood/Leather (oak, walnut)
- D: Wood (oak, walnut)

Holdbacks

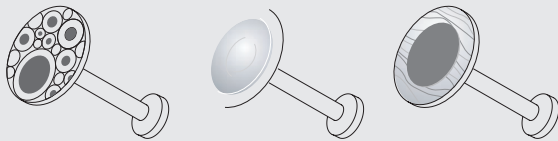

Medial designs can be used on matching holdback arms.

Please refer to the specific Metropole brochure for more detailed and colour descriptions.

Combine Metropole with Roman Blinds

All of the Metropole systems can be used to create a winning new look - the METROPOLE ROMAN (Silent Gliss Roman Blind system 2010). Using a new technique either tab-top or flat-heading Roman blinds are hung from the Metropole and operated by a patented cord-lock system.

Wave curtain heading system

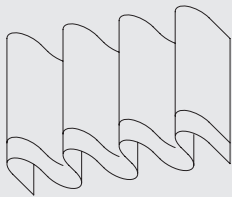

The Wave is an exciting new contemporary curtain heading system which allows curtains to hang in a continuous wave which is smooth, simple and elegant.

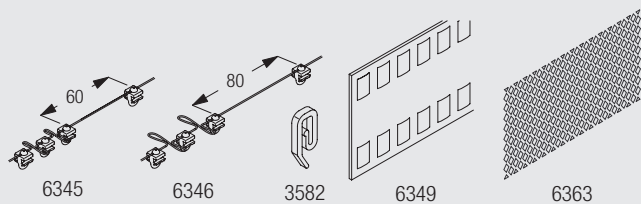

The Wave components are:

- 6345 Glider Cord 60mm
- 6346 Glider Cord 80mm
- 3582 Hook
- 6349 Curtain tape
- 6363 Iron tape



6130M

Fitting Information

Bracket Positioning when using standard brackets 3134-3136



The fixing points are for both available brackets identical.

For the standard bracket 3134-3136 or the ultra brackets 6133 and 6134

Fitting of track to brackets

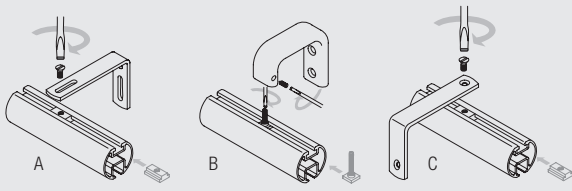

A: Using brackets 3134 - 3136

B: Using brackets 6133 and 6134

Fitting Options

Wall fix with brackets 3134/3135/3136 and bracket cover 3133

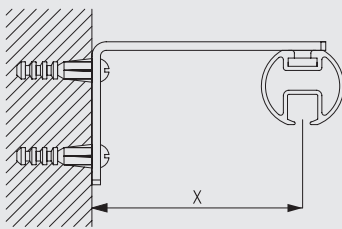

	X
3134	52mm
3135	72mm
3136	92mm

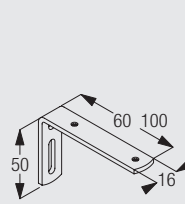

3134-36
Brackets

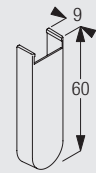

3133
Bracket cover
(60mm)

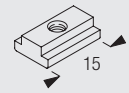

6141
Clamping piece

Wall fix with ultra brackets 6133 and 6134

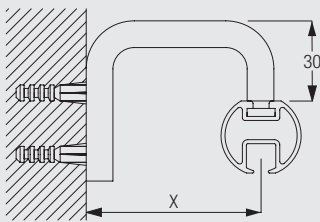

	X
6133	65mm
6134	115mm

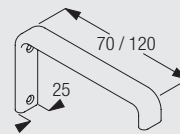

6133-34
Brackets

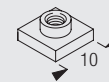

6117
Clamping piece

6130M

Ceiling fix with support 6138P

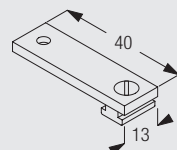
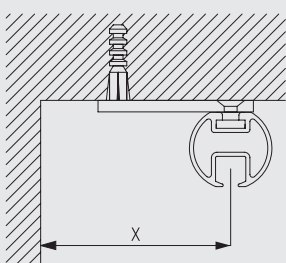

6138p
Ceiling Support

Standard Accessories

0707 End cover metal



3134 Bracket (60mm)



6103 Profile



3133 Bracket cover (60mm)











6065 Eye endstop

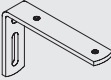
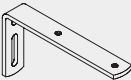

6143 Glider 6144 in strip form



Optional Accessories

0732	Hexagonal Nut		0733	M6 Washer for Midial	
0797a	Medial bracket		3135	Bracket (80mm)	
3136	Bracket (100mm)		3582	Hook	
6133	Bracket (70mm)		6134	Bracket (120mm)	
6138p	Ceiling Support		6143	Glider 6144 in strip form	
6283	Roller				



6130M



6130M

Hand Operated Curtain Pole System

Silent Gliss® 6140M Jumbo Metropole

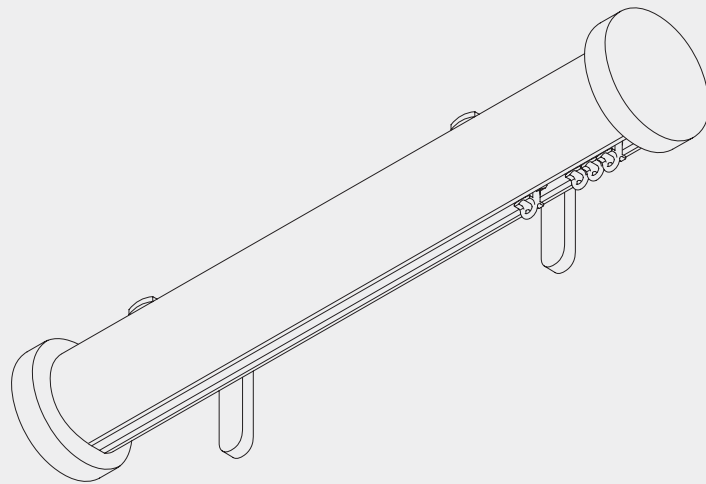

Product Information

-



6140M

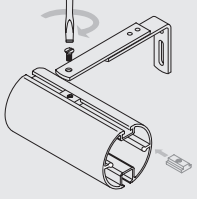

6140M

Hand Operated Curtain Pole System

Silent Gliss® 6103M Metropole

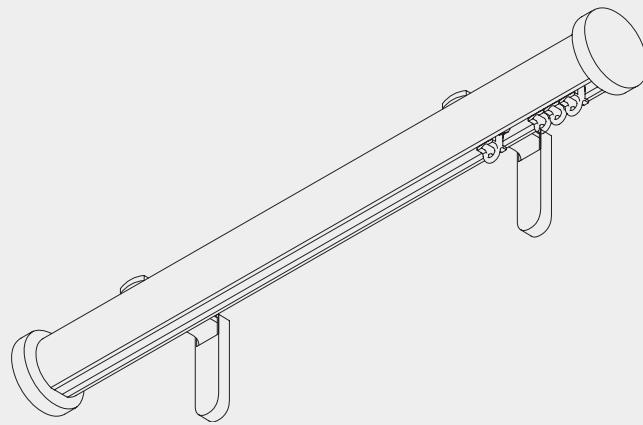

Product Information

- Hand operated system for domestic and contract applications.
- Attractive contemporary appearance for modern interiors.
- Unlike other poles, 6130 can be bent to a small radius for bay windows.
- Choice of 13 different finishes - gunmetal, black, white, diva gold, classic gold, chrome effect, anodised silver and wood effects; wenge, mahogany, cherry wood, teak, honey maple and beech.
- Metropole is available in six colour co-ordinated moods; mono, primavera, studio, overture, teatro and metropolitan.
- Poles, finials and midials can be mix and match purchased from these moods.
- Accessorised with matching end caps and co-ordinated or matching brackets/bracket covers.
- A wide range of finials is available for the 6130 hand operated system.
- A range of midials - a decoration projected in front of the pole - is available for Metropole. Midials cannot be used for ceiling fix applications. All midials can be used as holdbacks.
- Easy fitting to wall or ceiling with a choice of standard or 'ultra' brackets (for black, gunmetal, chrome effect, anodised silver and white only).
- For medium to heavy curtains.
- Can also be used with Roman Blinds - see Metropole Roman system 2010.



6103M

Profile and Bending Information

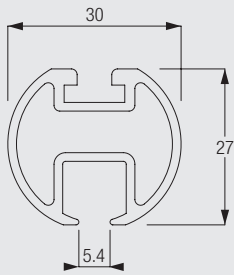

6103



Min. radius 30 cm

Design Options

Finials

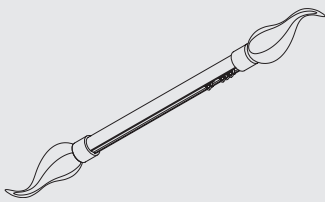

Finials are decorative elements that fit on at the end of the pole.

Please refer to the specific Metropole brochure for more detailed and colour descriptions.

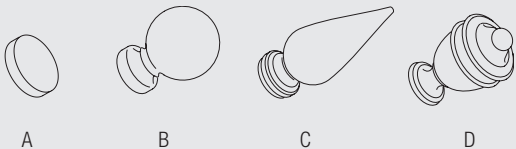

A: Without finials, endcaps with matching colour of the pole will be applied.

B: Ball End
C: Spear End
D: Urn End

6103M

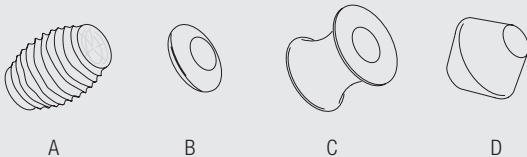

A: Cross Grain
B: Woodend Alpha
C: Woodend Beta
D: Woodend Gamma

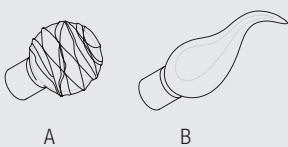

A: Trail Glass
B: Iris Clear

Medials

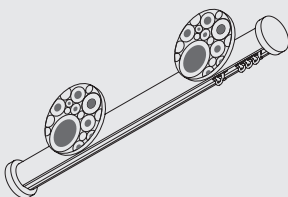

Medials are a certain pole decoration projected in front of the pole. They cannot be used for ceiling fix applications.

Please refer to the specific Metropole brochure for more detailed and colour descriptions.

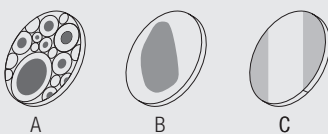

Medials with 90 mm diameter

A: Bamboo disc
B: Mother of Pearl Disc
C: Veener Disc

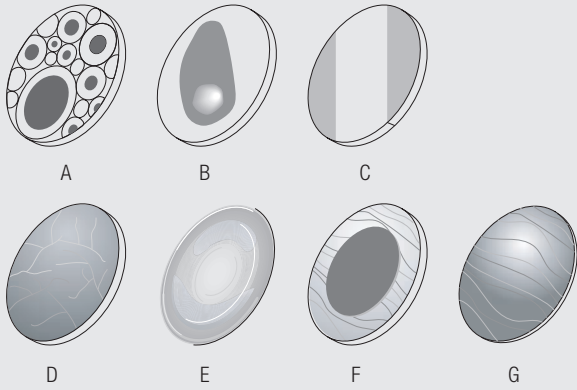

Medials with 100 mm diameter

- A: Crackle (fuchsia, lilac)
- B: Discus Glas (red, white amber, purple, lilac)
- C: Wood/Leather (oak, walnut)
- D: Wood (oak, walnut)

Holdbacks

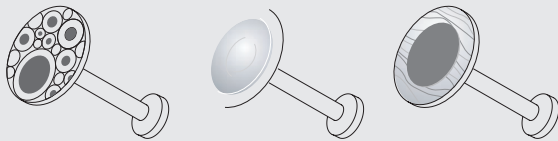

Medial designs can be used on matching holdback arms.

Please refer to the specific Metropole brochure for more detailed and colour descriptions.

Combine Metropole with Roman Blinds

All of the Metropole systems can be used to create a winning new look - the METROPOLE ROMAN (Silent Gliss Roman Blind system 2010). Using a new technique either tab-top or flat-heading Roman blinds are hung from the Metropole and operated by a patented cord-lock system.

Wave curtain heading system

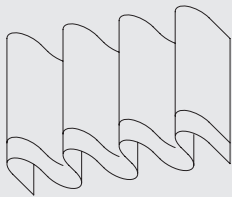

The Wave is an exciting new contemporary curtain heading system which allows curtains to hang in a continuous wave which is smooth, simple and elegant.

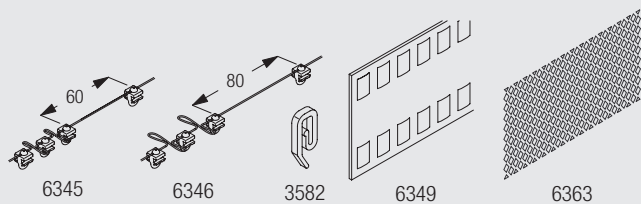

The Wave components are:

- 6345 Glider Cord 60mm
- 6346 Glider Cord 80mm
- 3582 Hook
- 6349 Curtain tape
- 6363 Iron tape



6103M

Fitting Information

Bracket Positioning when using standard brackets 3134-3136



The fixing points are for both available brackets identical.

For the standard bracket 3134-3136 or the ultra brackets 6133 and 6134.

Fitting of track to brackets

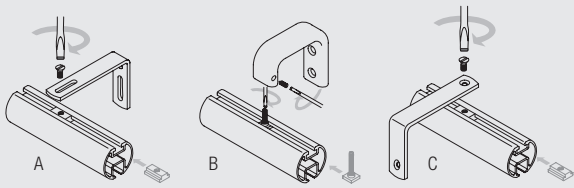

A: Using brackets 3134-3136

B: Using brackets 6133 and 6134

Fitting Options

Wall fix with brackets 3134/3135/3136 and bracket cover 3133

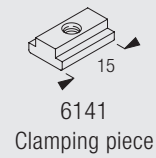
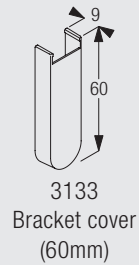
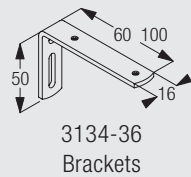
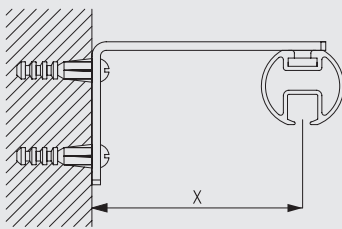

Wall fix with ultra brackets 6133 and 6134

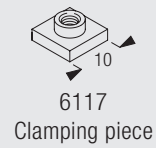
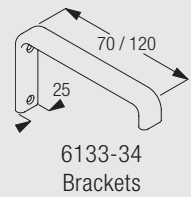
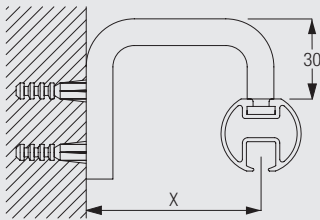

6103M

Ceiling fix with support 6138P

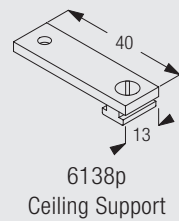
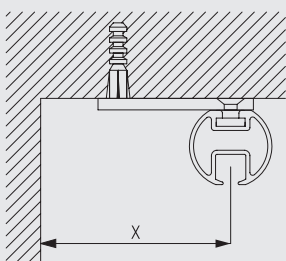

Standard Accessories

0707 End cover metal



3133 Bracket cover (60mm)



3134 Bracket (60mm)



6065 Eye endstop











6103 Profile

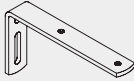

6143 Glider 6144 in strip form



Optional Accessories

0732	Hexagonal Nut		0733	M6 Washer for Midial	
0797a	Medial bracket		3135	Bracket (80mm)	
3136	Bracket (100mm)		3582	Hook	
6133	Bracket (70mm)		6134	Bracket (120mm)	
6138p	Ceiling Support		6143	Glider 6144 in strip form	
6283	Roller				





6103M



6103M

www.silentgliss.com
www.silentgliss.com
www.silentgliss.com

Silent Gliss International Ltd.
Worbstrasse 210
CH-3073 Gümligen

Silent Gliss International Ltd.
Worbstrasse 210
CH-3073 Gümligen

Silent Gliss International Ltd.
Worbstrasse 210
CH-3073 Gümligen