

# User Manual

March 2008

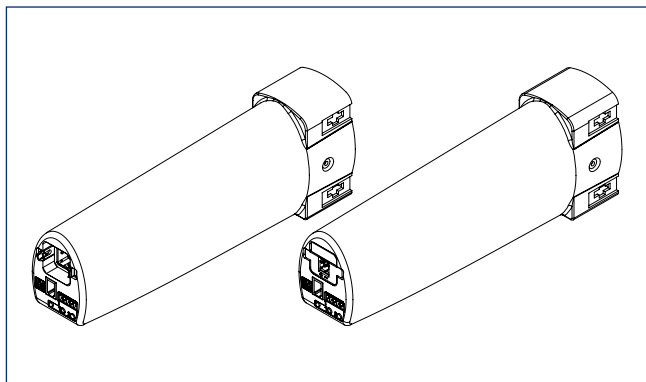

Motor Silent Gliss 9020, 9021, 9022, 9023  
Motor Silent Gliss 9030, 9031, 9032, 9033



## Table of Contents

Please read chapters „Intended application“ and „Safety Instructions“ before installing or connecting. Non-observance as well as opening and manipulation of the motor will result in voiding of the Silent Gliss liability and warranty.

1	Introduction and Product Overview	_____	4
2	Intended Application	_____	4
3	Safety Instructions	_____	5
4	Technical Specifications	_____	5
5	Connection and Operating Equipment	_____	6
6	Programming and operating of SG 9020/9021 and SG 9030/9031 motors	_____	11
7	Programming and operating of SG 9022/9023 and SG 9032/9033	_____	17
8	Group Control	_____	18
9	Troubleshooting	_____	20
10	Declaration of Conformity	_____	20

# 1 Introduction and Product Overview

This User Manual describes the setting up and programming of the different motor types, which are used in connection with the Silent Gliss Electrical Curtain Track System SG 5400 and SG 5420 as well as with the Radio Remote Control System SG 9940. Please refer to the separate fitting instructions and wiring diagrams for the installation of the Systems SG 5400 and 5420.

This User Manual applies to following Silent Gliss motor variations:

SG Nr.	ERP Nr.	Long description	Short description on motor
9020	100902000	Motor 90-250V AC*	9020.000.00
9021	100902101	Motor 90-250V AC*,radio 868MHz	9021.868.00
9021	100902102	Motor 90-250V AC*,radio 915MHz	9021.915.00
9022	100902200	Motor 90-250V AC*,manual override	9022.000.MO
9023	100902301	Motor 90-250V AC*,radio 868MHz, manual override	9023.868.MO
9023	100902302	Motor 90-250V AC*,radio 915MHz, manual override	9023.915.MO
9030	100903000	Motor 24V DC	9030.000.00
9031	100903101	Motor 24V DC, radio 868MHz	9031.868.00
9031	100903102	Motor 24V DC, radio 915MHz	9031.915.00
9032	100903200	Motor 24V DC, manual override	9032.000.MO
9033	100903301	Motor 24V DC, radio 868MHz, manual override	9033.868.MO
9033	100903302	Motor 24V DC, radio 915MHz, manual override	9033.915.MO

\*260V AC CB

## 2 Intended Application

- The motors mentioned in Chapter 1 may only be used in combination with the designated Silent Gliss Systems.
- The motor is solely designed for indoor use. Application in wet areas like bathrooms, indoor swimming-pools, saunas etc. is not permitted.
- Please note that Radio Control Systems are not permitted in certain locations such as Hospitals and Airports.
- Please ensure that other equipment is not being controlled by radio equipment using the same frequency.

### 3 Safety Instructions

- The Motor may be used only in dry rooms.
- The Motor may not be used in explosive areas.
- The Motor is not intended for use by young childrens or infirm persons without supervision.
- Only original Silent Gliss parts may be used.
- The installation, inspection and troubleshooting of the drive mechanism may only be performed by qualified specialists. Please consider the country specific regulations in regards of connection of the motors to the mains.
- The proper operation of the motor in combination with the Electric Curtain Track Systems is only guaranteed with professional installation, fixing, as well as sufficient electric power supply.
- Cleaning of the motor may only be performed if the motor is disconnected from the mains voltage.
- The motor must not be used if cables, plugs, or the motor are damaged.
- Please ensure the specification detailed below and in the declaration of conformity (page 20) conform with the necessary regulations in the intended country of use and the radio frequency is approved for that country.

### 4 Technical Specifications

Technical data for motors only. For the technical data for the entire curtain track system refer to the corresponding Assembling- / Fitting Instruction.

	<b>9020-9023</b>	<b>9030-9033</b>
Voltage Supply	90 - 250V AC**	24 V DC
Frequency	50 - 60 Hz	--
Current	0.5 - 1 A	2.5 A
Frequency of radio control (only for 9021/9023/9031/9033)	868 or 915 MHz*	868 or 915 MHz*
Speed	110 rpm	110 rpm
Noise level	< 45 dBA (30cm)	< 45 dBA (30cm)
Dimension	240 x 90 x 60mm	240 x 90 x 60mm
Weight	1kg	1kg
Max. drapery weight	44kg / 97lbs	44kg / 97lbs

Temperature ranges:

For operation	0 C to + 60 C	0 C to + 60 C
Storage	-20 C to + 70 C	-20 C to + 70 C
Safety class	IP40	IP40

\*(depending on regulation of respective country)

\*\*260V AC CB

## 5 Connection and Operating Equipment

### 5.1 Overview

The Motor is available in two power supply options; 90 – 250V AC/260V AC CB as well as 24V DC. The power plugs are designed differently and cannot be mixed up. The remaining ports and indicators are identical on both motors.

The following main overview of the ports and indicators may be used for both motors. The subsequent chapters deal in detail with the functions, allocations and setting of the ports and indicators.

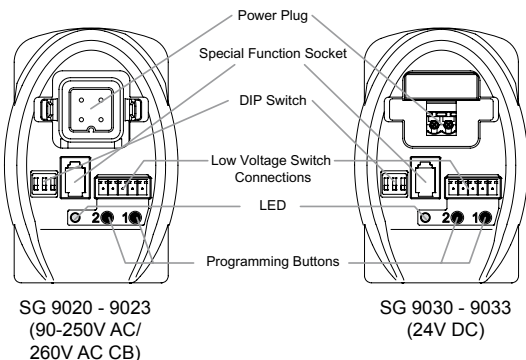

## 5.2 Special Function Socket

Used in connection with the Manual Override version for the motors SG 9022 / 9023 / 9032 / 9033.

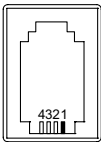

Pin	Denotation
1	GND
2	Endstop 1
3	Endstop 2
4	VCC

## 5.3 Low Voltage Switch Connections

Used for control by low voltage, group control or for the connection of the programming cable.

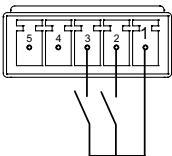

Pin	Denotation
1	Common
2	Open - Single
3	Close - Single
4	Open - Group
5	Close - Group

## 5.4 Programming Buttons

Used for the programming of the endstops as well as for the intermediate positions (scenes).

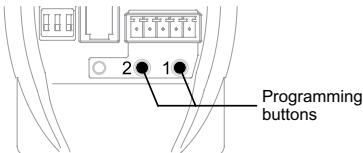

The numbers of the buttons are marked on housing of the motors. The right button is nr. 1, the left nr. 2.

## 5.5 LED

Flashes or is illuminated in the programming mode.

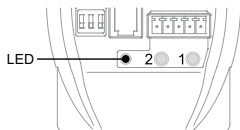

## 5.6 Mains Connection and Wiring of SG 9020 – 9023 (90 – 250V AC/260V AC CB)

Parallel jacketed thermoplastic cable, 300V with third conductor for grounding. (PVC)  
Minimum length 72.04" (1.83m)

Contact H-A 3BS 10421000

Contact H-A 3TGV 10426400

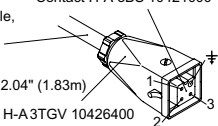

Pin	Denotation
1	Neutral
2	Phase (rotating direction left)
3	Phase (rotating direction right)
4	PE, $\perp$

**Wiring:** The motors SG 9020 – 9023 can be wired for non permanent power as well as for permanent power. The wiring is to be employed as required by local codes. The wiring diagrams are as follows:

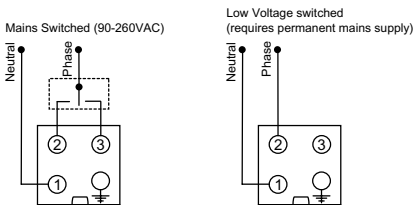

### Note!

The earth wire has to be wired according to the international wiring standards for buildings by reason of a proper grounding. The used switch must be equipped with a neutral terminal.



## 5.7 Mains Connection and Wiring of SG 9030 - 9033 (24V DC)

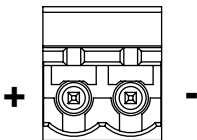

Wiring: The motors SG 9030 - 9033 are always connected with permanent power.

## 5.8 DIP - Switch Settings of SG 9020 - 9023 (90 - 250V AC/260V AC CB) and SG 9030 - 9033 (24V DC)

The DIP Switches are used to set the motor depending on the wiring and the required operation mode. Following table shows the possibilities.

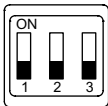

DIP Switch Position  
**"off-off-off"**

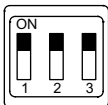

DIP Switch Position  
**"on-on-on"**

DIP Switch Position	Operational Mode
off-off-off	 <b>Controlled by switched mains</b>
on-off-off	<b>Controlled by low voltage switching</b> (requires permanent mains supply) <b>or Radio</b> Non Latching Switch: the motor will latch immediately it receives a momentary signal and continue to the pre set end position. To stop the motor while it is running apply a short signal in the opposite direction.
off-on-off	For vertical Blinds only. Use a non latching switch. Short pulses will rotate the angle of the blind but if the switch is held depressed for more than 1 second the motor will latch and the blind will run to the fully open or fully closed position.
on-on-off	Non latching switch: The motor will only run when the signal is present (switch depressed). Mainly used when the motor is being controlled from an AV or BMS controller.
off-off-on	As on-off-off but with the manual/electrical option enabled for use with a 5420 system.
on-off-on	As off-on-off but with the manual/electrical option enabled for use with a 5420 system.
off-on-on	As on-on-off but with the manual/electrical option enabled for use with a 5420 system.
on-on-on	Not applicable

**Important:**

When changing the DIP-mode please allways plug-off the motor first!

## 6 Programming and Operating of SG 9020/9021 and SG 9030/9031 Motors

### 6.1 Main Overview

After installation of a motor onto the designated Curtain Track System, the end stops – and if required, the intermediate positions can be programmed. This programming can be carried out in several ways: by means of the programming buttons on the motor, by means of the optional available Programming Cable SG 5651 or by means of the Radio Remote Control System SG 9940.

### 6.2 Programming by means of Programming Buttons on Motor or Programming Cable SG 5651

The following table shows the different steps required to program the final stops regardless of mains or low voltage switch type. If the Programming Cable SG 5651 is used to program the end stops, it is required to plug it into the Low Voltage Switch connection before programming.

Step	To do	Signal
1	Check if the DIP switch setting is correct (Setting according to Chapter 5.8).	
2	Disconnect power supply of the motor for 5 seconds and make sure that the motor will have permanent power supply when reconnected. Typically unplug power lead from motor.	

<b>3</b>	Reconnect to power supply and simultaneously push programming button 1 or 2.	Acoustic Signal, LED blinks
<b>4</b>	Simultaneously press both buttons (1&2) and hold depressed for > 6 seconds. After 3 seconds motor will sound and the light will flash. Do not release the buttons. Wait until motor sounds and light flashes for the second time. Motor is then in programming mode for 3 minutes.	Acoustic Signal and LED blinks after 3 and 6 seconds respectively
<b>5</b>	Use programming button 1 to drive the system to the first end stop position. Then press both buttons simultaneously for 3 seconds. This end position is then stored.	Acoustic Signal and LED blinks 1 x
<b>6</b>	Use programming button 2 to drive the system to the other end stop position. Then press both buttons simultaneously for 3 seconds. This end position is then stored.	Acoustic Signal and LED blinks 1 x

## 6.3 Programming by means of Radio Remote Control SG 9940

The remote control has to be taught-in with the motor before the programming of the end positions by means of the Radio Remote Control System can be performed. This can be carried out with the following steps. Please refer to the user manual which is enclosed with every delivered remote control.

<b>Step</b>	<b>Todo</b>	<b>Signal</b>
<b>1</b>	Check if the DIP switch setting is correct (Setting according to Chapter 5.8).	

2	Disconnect power supply of the motor for 5 seconds and make sure that the motor will have permanent power supply when reconnected. Typically unplug power lead from motor.	
3	Move the curtain with button 1 or 2 on the motor about to the middle position of the two endstops.	
4	Select the desired channel by pressing the select button (only SG 9942)	Channel LED on trans-mitter lights on
5	Position yourself in front of the motor with the remote control in your hand, and open the front cover of the device and press button „P“.	Curtain moves independently approx. 2 minutes open and close
6	To define the allocation of the buttons press first button on the transmitter as soon as the curtain begins to move in the first direction.	The curtain will come to a briefly hold
7	As soon as the curtain begins to move again, press the second button on the handheld transmitter. The transmitter has been successfully programmed.	The curtain will come to a stop

### Adjusting the endpositions

Step	To do	Signal
1	Check if the DIP switch setting is correct (Setting according to Chapter 5.8)	
2	Disconnect power supply of the motor for 5 seconds and make sure that the motor will have permanent power supply	
3	Establish power supply and simultaneously push programming button 1 or 2 on Motor.	Acoustic Signal, LED lights
4	Select the desired channel by pressing the select button (only SG 9942)	Channel LED on trans-mitter lights on

5	Push simultaneously programming button 1 and 2, >6 seconds. The motor is now able to be programmed for 3 minutes	Acoustic Signal and LED blinks after 3 and 6 seconds respectively
6	Move to first end position with programming button 1. Subsequently, push both programming buttons simultaneously for 3 seconds. The first end position is now saved	Acoustic Signal and LED blinks 1 x
7	Move to the second end position with programming button 2. Subsequently, push both programming buttons simultaneously for 3 seconds. The second end position is now saved	Acoustic Signal and LED blinks 1 x

## 6.4 Programming and Accessing of intermediate Positions

Two intermediate positions can be set for the Electric Curtain Track System with low voltage switching. The programming of the intermediate positions doesn't have to be carried out in the programming mode. It can be carried out in operational mode.

Programming with Low Voltage Control:

Step	To do	Signal
1	Use button 1 to move the system to the required scene position 1. When you reach the required position press button 2 twice while still holding down button 1	Acoustic Signal and LED blinks 1 x
2	Use button 2 to move the system to the required scene position 2. When you reach the required position press button 1 twice while still holding down button 2. The intermediate positions are now adjusted.	Acoustic Signal and LED blinks 1 x

Programming with Remote Control:

Step	To do	Signal
1	Press button 1 permanently and move the curtain to the desired intermediate position 1. Arrived at the first intermediate position, press button STOP simultaneously.	Acoustic Signal and LED blinks 1 x
2	Press button 2 permanently and move the curtain to the desired intermediate position 2. Arrived at the first intermediate position, press button STOP simultaneously.	Acoustic Signal and LED blinks 1 x

Recalling the intermediate positions: The curtain automatically moves to the programmed positions by briefly pressing 2 times the buttons which are assigned to the intermediate positions.

## 6.5 Resetting of Motor to Factory Status

Step	To do	Signal
1	Disconnect power supply of the motor for 5 seconds and make sure that the motor will have permanent power supply when reconnected. Typically unplug power lead from motor.	
2	Reconnect to power supply and simultaneously push programming button 1 or 2.	Acoustic Signal, LED blinks
3	Simultaneously press both buttons (1&2) and hold depressed for > 6 seconds. After 3 seconds motor will sound and the light will flash. Do not release the buttons. Wait until motor sounds and light flashes for the second time.	Acoustic Signal and LED blinks after 3 and 6 seconds respectively

## 6.6 Deleting transmitters 9940 to motors SG 9021/9023 and SG 9031/9033

### Transmitter 9941 (1-Channel)

Step	To do	Signal
1	Make shure that the motor has permanent power.	
2	Open the front cover on the device and press the following buttons <b>simultaneously</b> : - Programming button <b>P</b> - <b>STOP</b> button	
3	Keep these two buttons pressed until the LED goes out briefly.	LED turns off short

### Transmitter 9942 (5+1-Channel)

1	Make shure that the motor has permanent power.	
2a	<b>Deleting of a specified channel</b> Select the channel to be deleted. Then open the front cover and press the following buttons <b>simultaneously</b> : Programming button <b>P</b> + <b>STOP</b> button	
2b	Keep all of these buttons pressed until the LED flashes off short	LED flashes off short
3a	<b>Deleting of all channels</b> Select all Channel. Open the front cover and press the following buttons <b>simultaneously</b> : Programming button <b>P</b> + <b>UP</b> button + <b>STOP</b> button + <b>DOWN</b> button	
3b	Keep all of these buttons pressed until the LED flash off 3 x	LED flash off 3 x



## 7 Programming and Operating of SG 9022/9023 and SG 9032/9033

These motors and Electric Curtain Track Systems are equipped with a Manual Override function, i.e. the curtain can be moved by hand if the motor is turned off. This function is only applicable with a low voltage switching.. In addition, no intermediate position can be programmed.

The programming occurs through following steps

Step	To do	Signal
1	Check if the DIP switch setting is correct (Setting according to Chapter 5.8).	
2	Disconnect power supply of the motor for 5 seconds and make sure that the motor will have permanent power supply when reconnected. Typically unplug power lead from motor.	
3	Pull the curtain to about the middle position between the two end positions.	
4	Simultaneously press both buttons (1&2) and hold depressed for > 6 seconds. After 3 seconds motor will sound and the light will flash. Do not release the buttons. Wait until motor sounds and light flashes for the second time. Motor is then in programming mode for 3 minutes.	Acoustic Signal and LED blinks after 3 and 6 seconds respectively
5	Reconnect to power supply and simultaneously push programming button 1 or 2.	Acoustic Signal, LED lights
6	Move the curtain to one end position.	Motor stops automatically
7	Motor is programmed.	

## 8 Group Control of Motors

### 8.1 Group Control via Mains

Motors can be connected in parallel when mains switching. 3 motors maximum are recommended. If quantities above 3 motors in parallel are required, a qualified electrician must be consulted to ensure that the supply, wiring and switching is suitable for the electrical load.

For motors to all run in the same direction on command attention must be paid to ensure that the connections to all motors are identical. If a motor is specifically required to operate in the reverse direction on command the connections to pins 2 & 3 should be reversed on that specific motor.

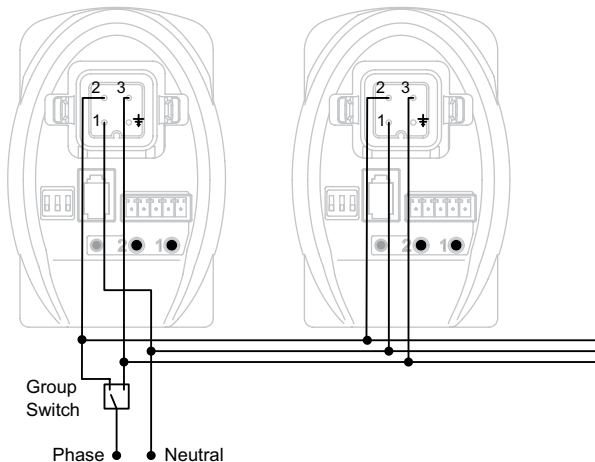

## 8.2 Group Control via Low Voltage Inputs (max. 15)

If a motor is required to run in the opposite direction to others wired within the same group connections 2 & 3 at the low voltage switch connection should be reversed on that specific motor.

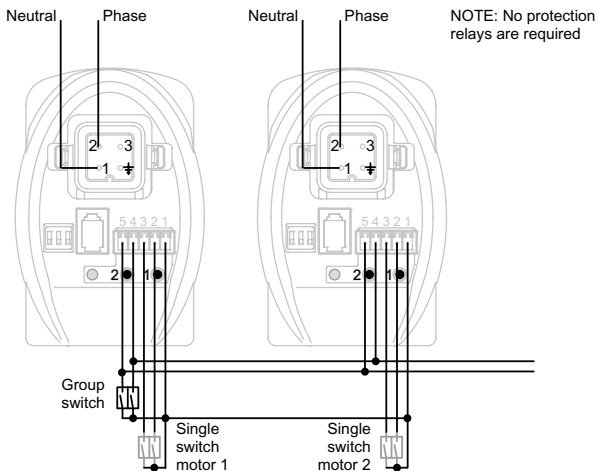

## 8.3 Group Control via Radio Remote Control SG 9940

For the programming of the group control by means of the radio remote control system SG 9940 please refer to the user manual which is enclosed in every delivered hand remote control device.

## 9 Troubleshooting

... the motor doesn't move?

- Check if motor is correctly supplied with power according to the wiring diagram and if the DIP switches are in the right position.

... the motor doesn't move after saving the first end stop?

- Disconnect power supply. Start limit setting process again ensuring that button 1 is used first to drive the system to its first limit position.

... the motor turns in the wrong direction with low voltage switching (permanent power supply)

- Exchange cable of Pin 2 with Pin 3 at the low voltage switch terminal connection.

... the motor SG 9020 turns in the wrong direction with mains switched connection?

- Exchange cable of Pin 2 and 3 on mains plug.

... some motors 9020 / 9022 turn in the wrong direction when connected for simultaneous operation using mains switching.

- Check if Pin 2 and Pin 3 on each motor are connected identically.

## 10 Declaration of Conformity

Micro- Motor AG confirms herewith that this product complies with the relevant harmonised regulations of the 73 / 23 / EEC + 89 / 336 / EEC + 93 / 68 / EEC directives. The declaration of conformity can be ordered at: [info@micromotor.ch](mailto:info@micromotor.ch) .