

Special Systems





Design Case

Silent Gliss® 4130

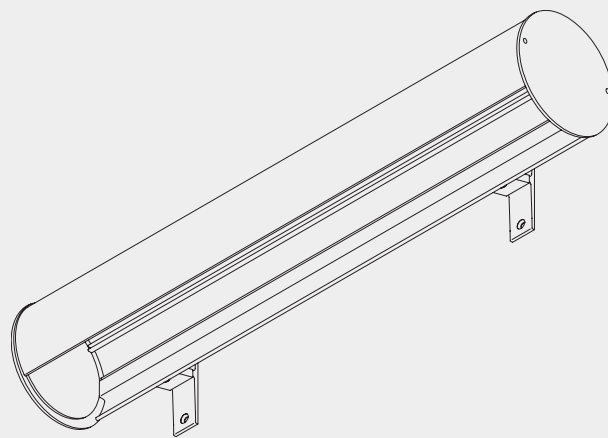

Product Information

- A perfect design element for contract and residential applications.
- To be used with following Silent Gliss Systems: Vertical blind Systems 2810, 2900, 2950; Electric Curtain Systems 5300; Panel Systems 2700 4-channel, 2600, 2650; Roller Blind Systems 4800, 4810, 4810DF, 4820, 4850, 4860.
- Easy fitting to ceilings, wall or recess, also with hangers.
- Standard colours: aluminium anodized and white powder coated (RAL colours on demand)
- With special corner piece also for corner applications.
- System length is variable thanks profile connector.
- Visual harmonic effect through matching end and profile caps.



4130

Profile Information

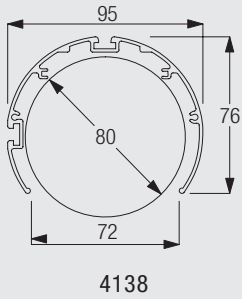

Only for straight systems.

System Applications

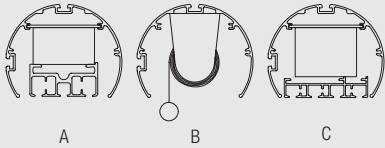

A: For Electric Curtain System 5300 (with mounting profile 4117 and distance piece 4145)
 B: For Roller Blind Systems 4800, 4810, 4810DF, 4820, 4850, 4860
 C: For Panel Glide System 2700/4 channels (with mounting profile 4117 and distance piece 4146)

Note: The systems 2810, 2900, 2950, 5400, 5420, 5200, 5220, 2600 and 2650 can also be used.

Fitting Options

Ceiling Fitting with mini-hanger 6175

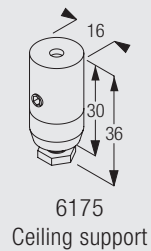
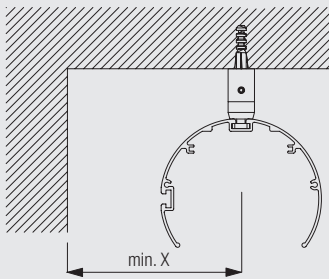

X = The final distances from the wall/window depend on barriers like radiators, window handle, window ledge, etc.

Ceiling Fitting with hanger 6190

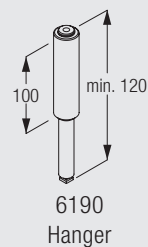
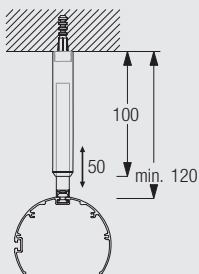

The final distances from the wall/window depend on barriers like radiators, window handle, window ledge, etc.

Wall Fitting with adjustable bracket 4175

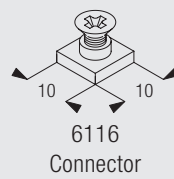
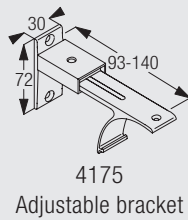
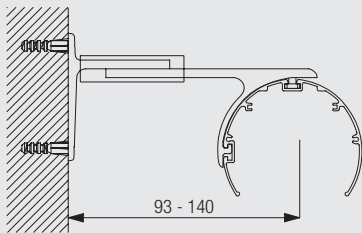

Standard Accessories

4117 Mounting profile



4118 Endcover



4138 Profile



4145 Distance piece 30mm



4146 Distance piece 40mm



6125 Corner connection



6516 Connecting bridge

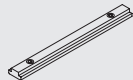

Usefull Measurements

4117 Mounting profile

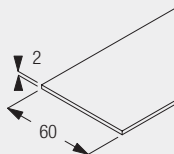

4145 Distance piece 30mm

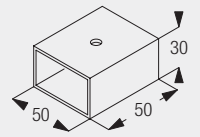

4146 Distance piece 40mm

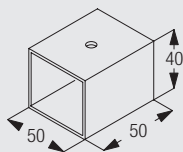

4130



4130



4130

www.silentgliss.at
www.silentgliss-russia.com
www.silentgliss-cee.com

Silent Gliss GesmbH
Gewerbestraße 6
A - 6710 Nenzing
Tel. + 43 (0) 5525 64 111
Fax. + 43 (0) 5525 63 170

Silent Gliss GesmbH
Jochen-Rindt-Straße 1
A - 1230 Wien
Tel. + 43 (0) 1 615 02 72
Fax. + 43 (0) 1 615 02 72-88

Silent Gliss GesmbH
Vertriebsbüro / Showroom
Stubenring 6
A – 1010 Wien
Tel. +43 (0) 1 513 16 77
Fax. +43 (0) 1 513 16 77-88