

Room Divider Systems

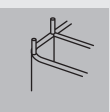



Room Divider System

Silent Gliss® 1003

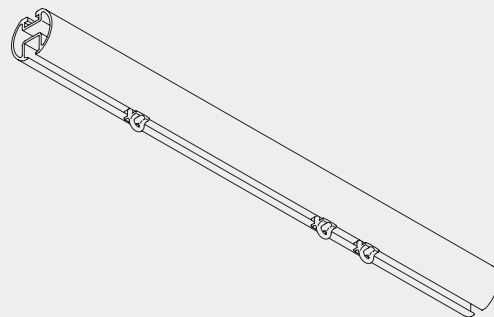

Product Information

- Hand operated, attractive contemporary rounded curtain track for residential and contract applications.
- For light and medium weight curtains.
- Very flexible system which can be used as a decorative element as well as a multifunctional room divider system.
- For straight and bended applications.
- Standard colours: anodised aluminium or white powder coated.
- System is designed for ceiling and wall fixing, as well as suspension with hangers.
- Standard length of the profiles is 6 m
- Large and attractive fabric offer.



1003

Profile and Bending Information

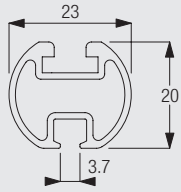

1003



Min. radius 15 cm

Fixing Points



Fitting Options

CAD download through Silent Gliss Extranet / Downloads

Ceiling fitting with bracket 6124

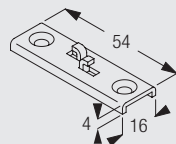
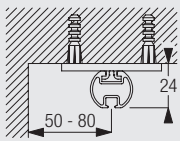

6124
Bracket

The final distances from the wall depend on curtain weight, make-up and any obstructions.



1003

Ceiling fitting with ceiling support 6175

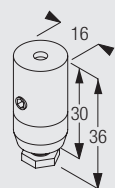
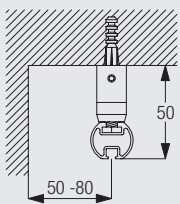

6175
Ceiling support

The final distances from the wall depend on curtain weight, make-up and any obstructions.

Ceiling fitting with hanger 6190 (also suspended ceilings) and wall bracket 3042

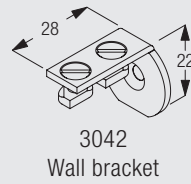
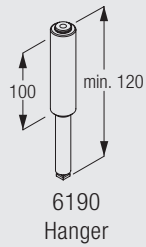
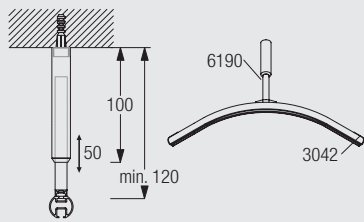

Ca. all 800 - 1000 mm a Hanger 6190.

The final distances from the wall depend on curtain weight, make-up and any obstructions.

Wall fitting with brackets 6181 / 6182

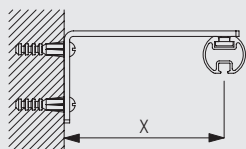

	X (mm)
6181	43
6182	93

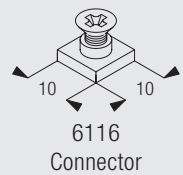
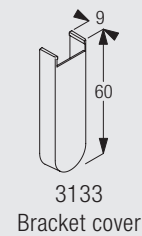
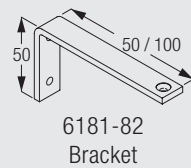

Wall fitting with brackets 3144 / 3145

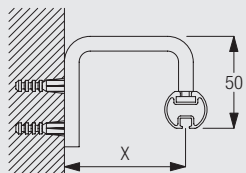

	X (mm)
3144	70
3145	120

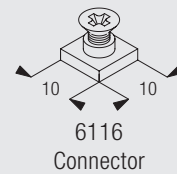
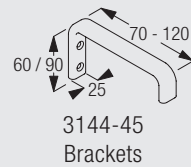

1003

Standard Accessories

3070 End stop



3085 Spring stop



3533 Glider



3599 Hook



Optional Accessories

3534 Glider 3533 in strip form



3537 Glider



3548 Clic-glider



3549 Clic-hookglider



3581 Hook



3582 Hook



3598 Eyelet



6110 Dust cover



6146 Hook (for shower curtains with eyelets)



Useful Measurements

3014 Endcover

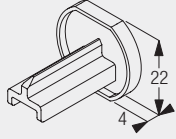

3146 Endcover

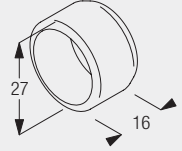

6125 Corner connection

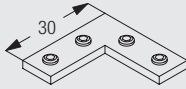

6516 Connecting bridge

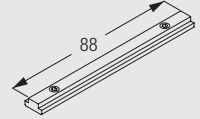

1003



1003

www.silentgliss.at
www.silentgliss-russia.com
www.silentgliss-cee.com

Silent Gliss GesmbH
Gewerbestraße 6
A - 6710 Nenzing

Tel. + 43 (0) 5525 64 111
Fax. + 43 (0) 5525 63 170

Silent Gliss GesmbH
Jochen-Rindt-Straße 1
A - 1230 Wien

Tel. + 43 (0) 1 615 02 72
Fax. + 43 (0) 1 615 02 72-88

Silent Gliss GesmbH
Vertriebsbüro / Showroom
Stubenring 6
A – 1010 Wien

Tel. +43 (0) 1 513 16 77
Fax. +43 (0) 1 513 16 77-88