

# Room Divider Systems

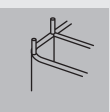



## Room Divider System

# Silent Gliss® 1085

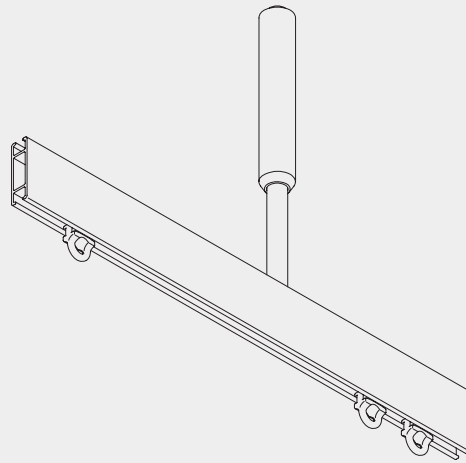

### Product Information

- Attractive room divider system for light to medium residential applications.
- Also used for applications e.g. showers, baths etc.
- Elegant and bendable reversible profile (symmetrical).
- Standard colours: anodised aluminium or white powder coated.
- Standard profile length: 6 m
- The design detail gives rigidity and strength with great flexibility in layout.
- Applicable for light to medium curtains, there are almost no limits set to size and layouts.
- Easy ceiling or wall fixing.
- Large and attractive fabric offer.



1085

## Profile and Bending Information

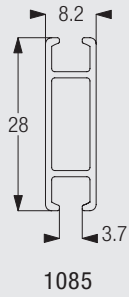

## System Layout Options

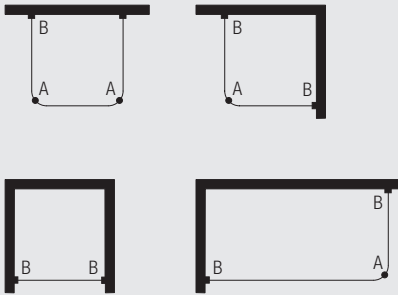

A: Hanger rod 3625  
B: Wall support 3652

## Fixing Points with Hanger

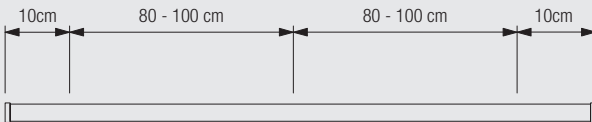

1085

## Fitting Options

CAD download through Silent Gliss Extranet / Downloads

### Ceiling fitting with hanger 3625 and wall support 3652

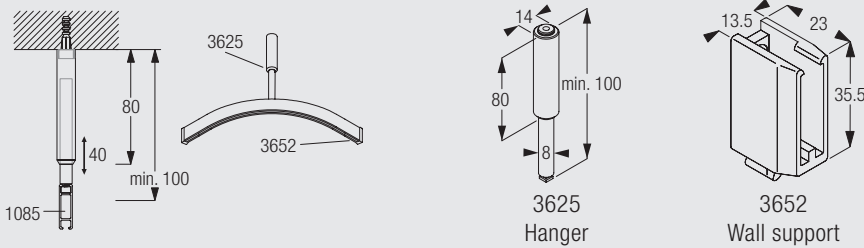

The final distances from the wall depend on curtain weight, make-up and any obstructions

## Wall fitting with wall support 3652

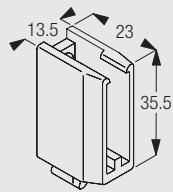
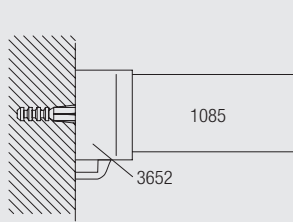

3652  
Wall support

### Standard Accessories

3070 End stop



3085 Spring stop



3533 Glider



3599 Hook



### Optional Accessories

3534 Glider 3533 in strip form



3537 Glider



3548 Clic-glider



3549 Clic-hookglider



3581 Hook



3582 Hook



3598 Eyelet



6146 Hook (for shower curtains with eyelets)



1085

### Useful Measurements

3656 Endcover

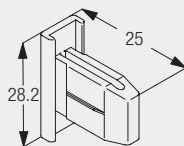



1085



1085

[www.silentgliss.at](http://www.silentgliss.at)  
[www.silentgliss-russia.com](http://www.silentgliss-russia.com)  
[www.silentgliss-cee.com](http://www.silentgliss-cee.com)

Silent Gliss GesmbH  
Gewerbestraße 6  
A - 6710 Nenzing  
Tel. + 43 (0) 5525 64 111  
Fax. + 43 (0) 5525 63 170

Silent Gliss GesmbH  
Jochen-Rindt-Straße 1  
A - 1230 Wien  
Tel. + 43 (0) 1 615 02 72  
Fax. + 43 (0) 1 615 02 72-88

Silent Gliss GesmbH  
Vertriebsbüro / Showroom  
Stubenring 6  
A – 1010 Wien  
Tel. +43 (0) 1 513 16 77  
Fax. +43 (0) 1 513 16 77-88