

Roller Blind Systems





Design Case

Silent Gliss® 4140

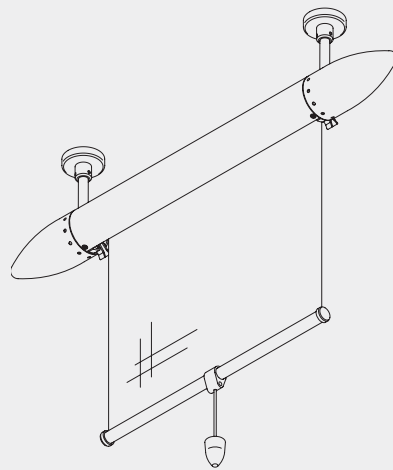

Product Information

- A very special Design Case for residential as well as contract market applications.
- Suitable for use with hand operated systems 4800, 4810DF or the motorized 4850.
- Available in various attractive colours like anodised silver, black, chrome, other powder coatings etc. and with matching accessories.
- The Design Case 4140 is available at any chosen width between 50 - 200 cm. The maximum drop is 280 cm, depending on the quality of the fabric.
- Systems can be mounted side-by-side thanks to a special intermediate design bracket.
- Easy mounting to ceiling or wall.



4140

Profile Information

Design Case

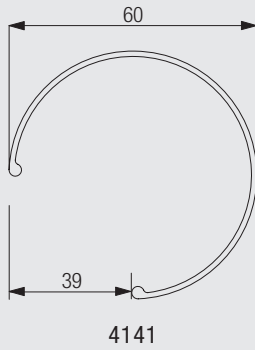

How to measure

System Measurements with Design Case Endcaps

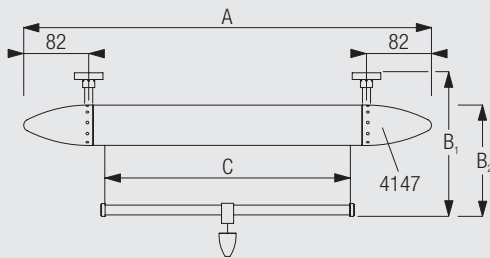

- A: System width
- B1: System drop (ceiling fix)
- B2: System drop (wall fix)
- C: Fabric width

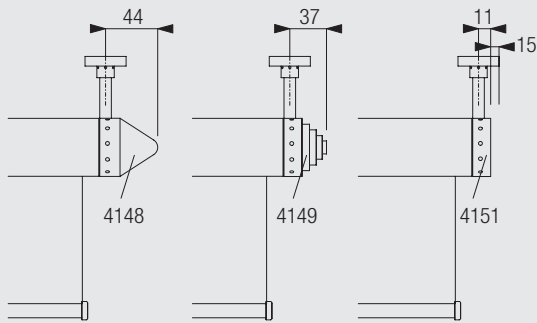

- 4147: End cover "Bolide"
- 4148: End Cover "Circus"
- 4149: End Cover "Icicle"
- 4151: End Cover "Puck"

Attention: The total width of the system includes the width of the design endcaps.

Side-by-side fitting

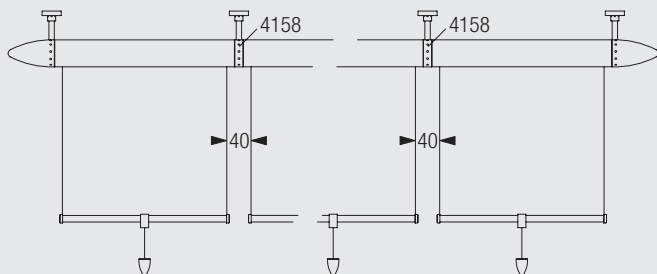

- 4158: Intermediate bracket (16 mm)

Multiple systems can be fitted side-by-side.

System Dimensions



2 m



0,50 m



2,8 m

Maximum Drop of Design Case 4140 depends on fabric quality

Fabric width according to end covers

Endcover	Fabric width =
Bolide	System width - 22.5 cm
Circus	System width - 14.5 cm
Icicle	System width - 13.5 cm
Puck	System width - 7.5 cm

Design Elements

Endcaps

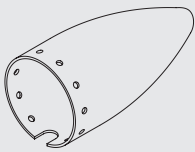

4147

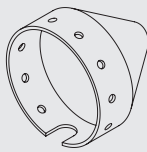

4148



4149



4151

4147: "Bolide"
4148: "Circus"
4149: "Icicle"
4151: "Puck"

Grips

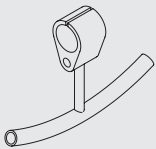

4153



4154

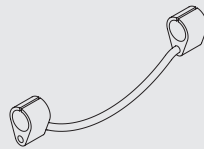

4152

4152: "Pull"
4153: "Anchor"
4154: "Bullet"



4140

Available in exclusive colours (matt silver, black, chrome, metallic blue, metallic green, mettalic red, metallic gold und metallic anthracite).

Bracket Positioning

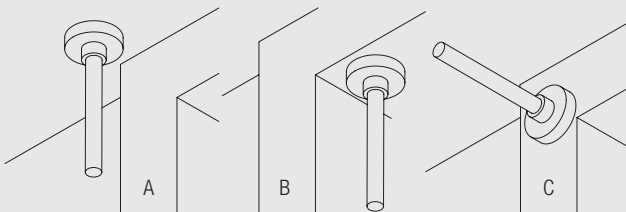

A: Ceiling Fixing
B: Recess Fixing
C: Wall Fixing

Please note that if fitted inside recess, all endcovers including "Puck" will leave a light gap.

Ceiling Fitting

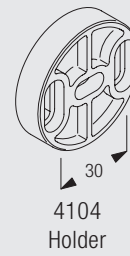
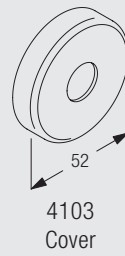
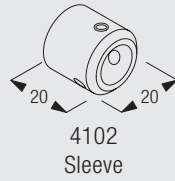
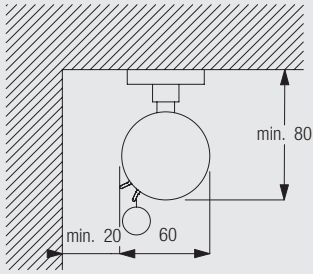

The final distances from the wall/window depend on barriers like radiators, window handle, window ledge, etc.

Wall Fitting

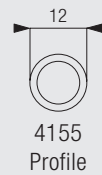
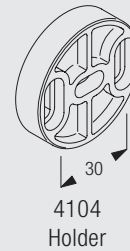
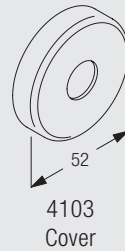
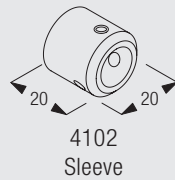
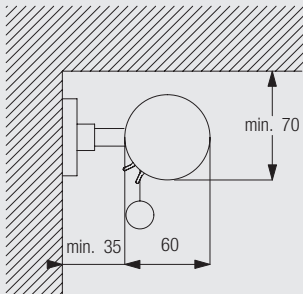

Standard Accessories



4140

Bracket-set composed of:

4102	Sleeve		4103	Cover	
4104	Holder		4139	Endcover für weight bar	
4155	Profile		4161	Bearing	
4162	Flange		4163	Safety device	
4164	Safety device		4165	Weight bar	
4187	Strip				

Design Elements (Optional)

4147 Endcover (Bolide)



4148 Endcover (Circus)



4149 Endcover (Icicle)



4151 Endcover (Puck)



4152 Pull grip



4153 Anchor grip



4154 Bullet grip



Optional Accessories

4158 Connector



4140

www.silentgliss.at
www.silentgliss-russia.com
www.silentgliss-cee.com

Silent Gliss GesmbH
Gewerbestraße 6
A - 6710 Nenzing
Tel. + 43 (0) 5525 64 111
Fax. + 43 (0) 5525 63 170

Silent Gliss GesmbH
Jochen-Rindt-Straße 1
A - 1230 Wien
Tel. + 43 (0) 1 615 02 72
Fax. + 43 (0) 1 615 02 72-88

Silent Gliss GesmbH
Vertriebsbüro / Showroom
Stubenring 6
A – 1010 Wien
Tel. +43 (0) 1 513 16 77
Fax. +43 (0) 1 513 16 77-88