

# Roman Blind Systems





## Roman Blind System

# Silent Gliss® 2020

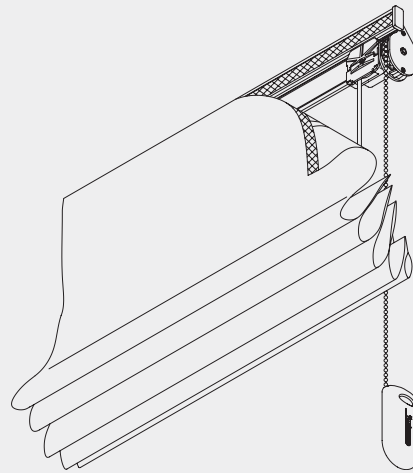

### Product Information

- Chain operated Roman blind system for residential and contract applications.
- Extremely smooth and fast (1:1 gearing) operation.
- Blind stops at any required height without slippage even with heavier blinds.
- Very elegant appearance as profile, all hardware components and the operation chain are hidden behind the blind.
- Fabric can be easily removed from headrail for washing/maintenance.
- Left or right hand operation.
- Maximum dimensions are 2,5 m for the width, and 3,0 m for the height. All dimensions depend on total blind weight including bottom weight bar.
- Max. curtain weight: 3 kg (including bottom weight bar)
- The top stack of the fabric takes up about 15-20% of the blind drop (depending on fabric make-up).
- Easy ceiling or wall fitting to all surfaces.
- Delivered ready assembled. Large and attractive fabric offer.



2020

## Profile and Bending Information

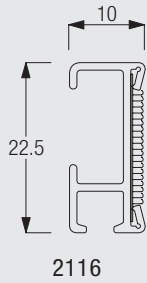

Only for straight Systems

## System Dimensions



2,5 m



3 m



7,5



3 kg (incl. bottom weight bar)

The system dimensions depend on the total fabric weight including the bottom weight bar.

## System Options

### Sloping Windows Option

With the optional special guide 2204 and the bead chain connector 2826, the system 2020 can also be used for sloping window applications up to a maximum inclination of 45°. Please refer to the technical service for more information.

## Bracket Positioning



2020

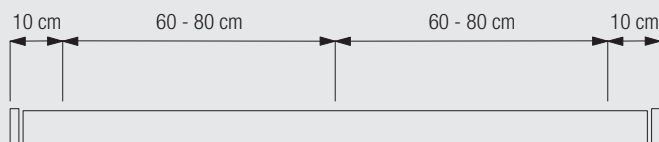

## Fitting Options

### Ceiling fitting with bracket 3603

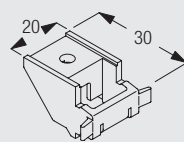
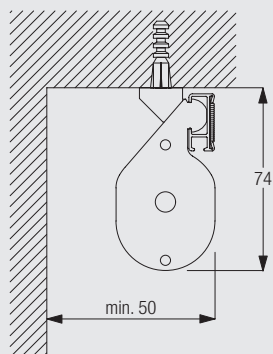

3603  
Bracket

The final distances from the wall/window depend on barriers like radiators, window handle, window ledge, etc.

### Wall fitting with brackets 3655 and 3660

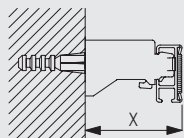

|      | X (mm) |
|------|--------|
| 3655 | 53     |
| 3660 | 65     |

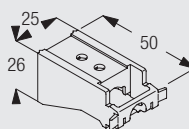

3655  
Bracket

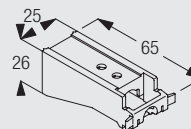

3660  
Bracket

### Wall fitting with brackets 3134-39 and bracket 3603

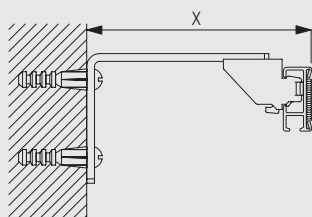

|      | X (mm) |
|------|--------|
| 3134 | 77     |
| 3135 | 97     |
| 3136 | 117    |
| 3137 | 137    |
| 3138 | 167    |
| 3139 | 217    |

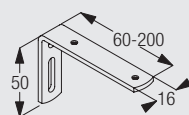

3134-39  
Brackets

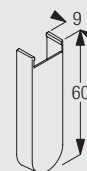



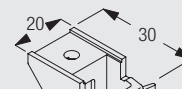









3133  
Bracket cover

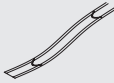

3603  
Bracket

### Standard Accessories

|      |                      |   |      |                                       |   |
|------|----------------------|---|------|---------------------------------------|---|
| 2016 | Weight bar           |   | 2023 | Winding-up element                    |   |
| 2049 | Gear drive           |  | 2059 | Safety clip                           |  |
| 2093 | Ring                 |  | 2111 | Axle                                  |  |
| 2131 | Endcover             |  | 2539 | Tape                                  |  |
| 2865 | Bead chain connector |  | 2872 | Plastic bead chain                    |  |
| 3055 | Hook                 |  | 3074 | Loop tape (delivery only with fabric) |  |
| 3340 | Cord/Chain weight    |  |      |                                       |   |

2020



2020



2020

[www.silentgliss.at](http://www.silentgliss.at)  
[www.silentgliss-russia.com](http://www.silentgliss-russia.com)  
[www.silentgliss-cee.com](http://www.silentgliss-cee.com)

Silent Gliss GesmbH  
Gewerbestraße 6  
A - 6710 Nenzing  
Tel. + 43 (0) 5525 64 111  
Fax. + 43 (0) 5525 63 170

Silent Gliss GesmbH  
Jochen-Rindt-Straße 1  
A - 1230 Wien  
Tel. + 43 (0) 1 615 02 72  
Fax. + 43 (0) 1 615 02 72-88

Silent Gliss GesmbH  
Vertriebsbüro / Showroom  
Stubenring 6  
A – 1010 Wien  
Tel. +43 (0) 1 513 16 77  
Fax. +43 (0) 1 513 16 77-88