

Cord Operated Curtain Track Systems

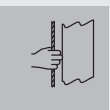



Cord Operated Curtain Track System

Silent Gliss® 6350

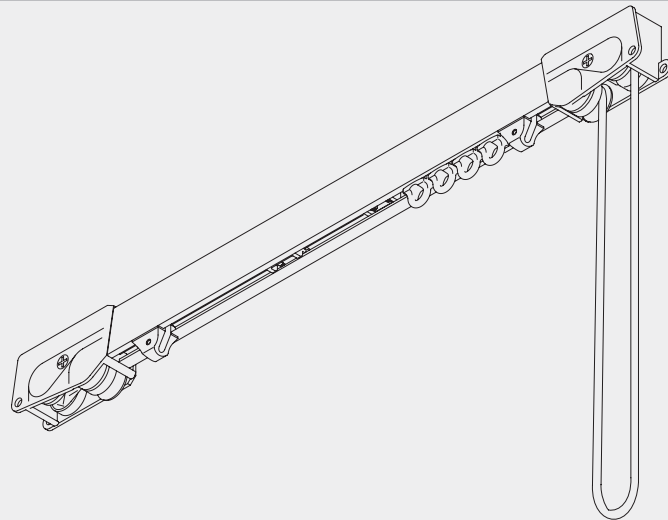

Product Information

- Cord operated curtain track system for contract as well as residential use.
- For medium weight applications.
- The maximum length of the system is 12 , depending on fabric weight, application and use of gliders or rollers.
- Strong profile with concealed channel.
- Fixing to wall or ceiling.
- Standard colours: anodised aluminium or white powder coated.
- Standard length of the profiles is 6 m.
- Large and attractive fabric offer.
- All regular curtain heading systems as well as Wave can be applied with Silent Gliss 6350.



6350

Profile and Bending Information

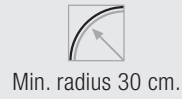
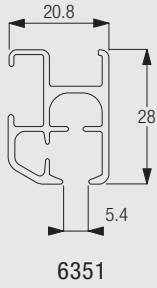

How to measure

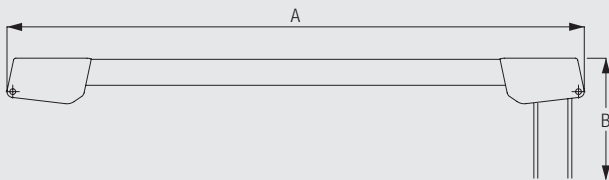

A: System width
B: Cord height

System Dimensions



12 m



39 kg

Max. Curtain Weight Chart (with gliders)



	2 m	4 m	6 m	8 m	10 m	12 m
	24	22	20	19	17	15
	28	26	25	23	22	20
	22	19	16	13	10	-
	25	22	19	16	13	-
	17	15	13	10	8	-
	22	19	16	13	10	-

(kg max.)

Max. Curtain Weight Chart (with rollers)

	2 m	4 m	6 m	8 m	10 m	12 m
	34	33	31	29	27	25
	39	37	35	33	32	30
	27	24	21	18	15	-
	32	29	26	23	20	-
	22	20	18	15	13	-
	27	24	21	18	15	-

(kg max.)

System Options

Wave curtain heading system

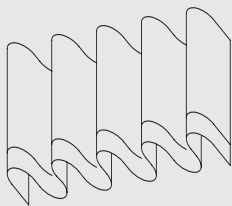

Wave is an exciting new contemporary curtain heading system which allows curtains to hang in a continuous wave which is smooth, simple and elegant.

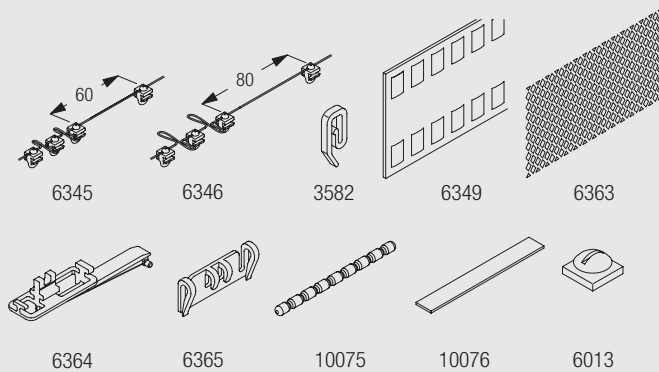

The Wave components are:

- 3582 - Hook
- 6013 - Endstop
- 6345 - Glider cord 60 mm
- 6346 - Glider cord 80 mm
- 6349 - Curtain tape
- 6363 - Iron tape
- 6364 - Extension
- 6365 - Hanger
- 6366 - Carrier for draw rod
- 10075 - Lead weight 50 gr/m
- 10076 - Fabric weight
- 2255 - Brake comb.



6350

Fixing Points

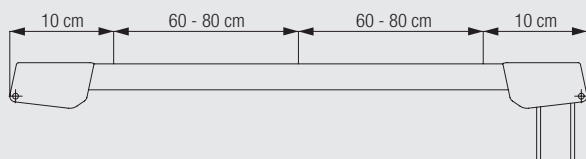

Fitting Options

Ceiling fitting with bracket 3603

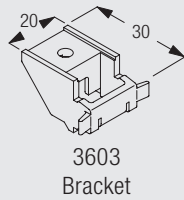
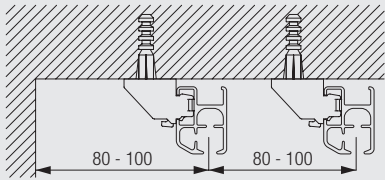

The final distances from the wall depend on curtain weight, make-up and any obstructions.

Wall fitting with brackets 3630, 3655 and 3660

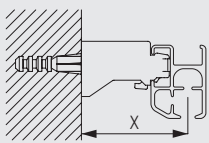

	X (mm)
3630	42
3655	57
3660	72

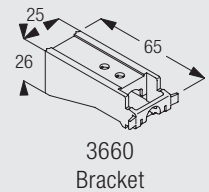
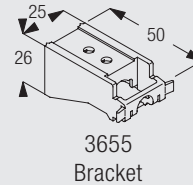
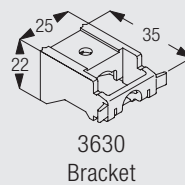

Wall fitting with extension brackets 3134-3139 and bracket 3603

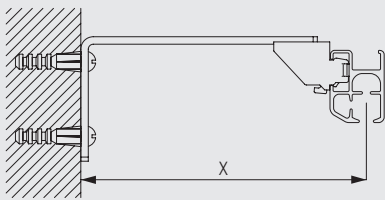

	X (mm)
3134	79
3135	99
3136	119
3137	139
3138	169
3139	219

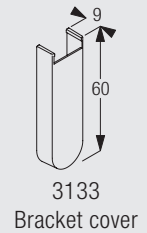
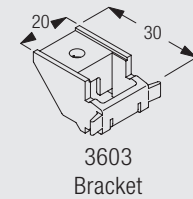
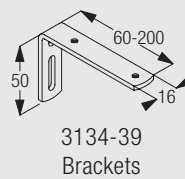

6350

Wall fitting with bracket 3239 and bracket 3603

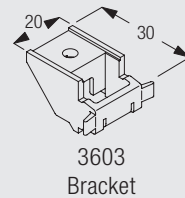
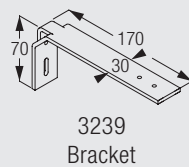
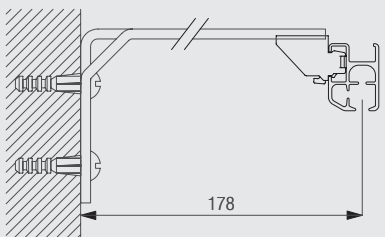

Wall fitting with bracket support 3271 and brackets 3272-3274 and 3603

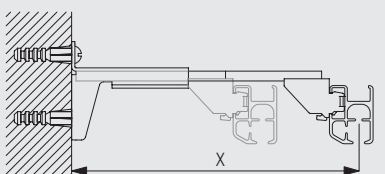

	X (mm)
3271/3272	87-122
3271/3273	122-137
3271/3274	137-172

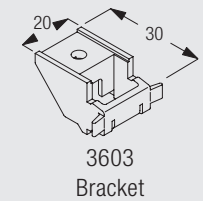
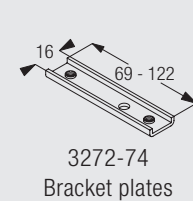
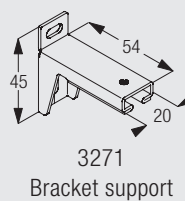

Standard Accessories

3599 Hook



3735 Cord tensioner with spring



6086 Spring stop



6283 Roller



Optional Accessories

3581 Hook



6065 Endstop



6098 Roller



Connecting bridge - Set

9301 composed of:

3620 Connecting bridge

1 x

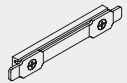

6362 Connecting bridge

1 x

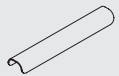

6350

www.silentgliss.at
www.silentgliss-russia.com
www.silentgliss-cee.com

Silent Gliss GesmbH
Gewerbestraße 6
A - 6710 Nenzing
Tel. + 43 (0) 5525 64 111
Fax. + 43 (0) 5525 63 170

Silent Gliss GesmbH
Jochen-Rindt-Straße 1
A - 1230 Wien
Tel. + 43 (0) 1 615 02 72
Fax. + 43 (0) 1 615 02 72-88

Silent Gliss GesmbH
Vertriebsbüro / Showroom
Stubenring 6
A – 1010 Wien
Tel. +43 (0) 1 513 16 77
Fax. +43 (0) 1 513 16 77-88