

Cord Operated Curtain Track Systems

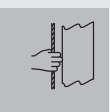



Cord Operated Curtain Track System

Silent Gliss® 5850

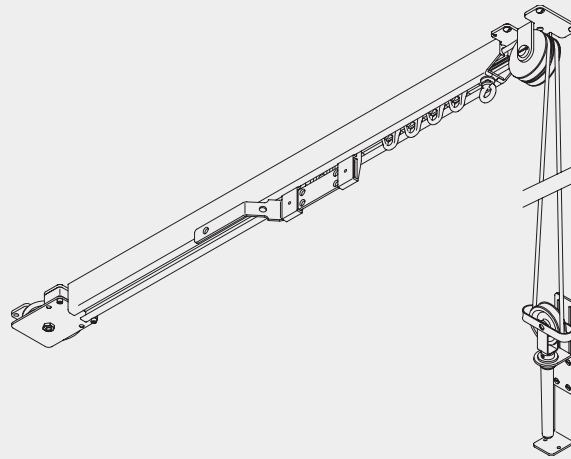

Product Information

- Curtain track system for very heavy curtains.
- The maximum length of the system is 20 m. However, the length depends on fabric weight and application.
- For horizontal, straight or bended applications with single, double or multiple symmetrical stacks.
- Only for ceiling fix.
- Standard colours: anodised aluminium or white powder coated.
- Standard length of the profiles is 6 m.
- Operation with either crank or cord tensioner.



5850

Profile and Bending Information

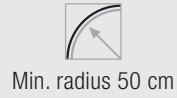
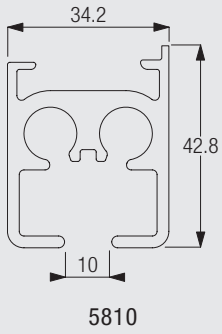

How to measure

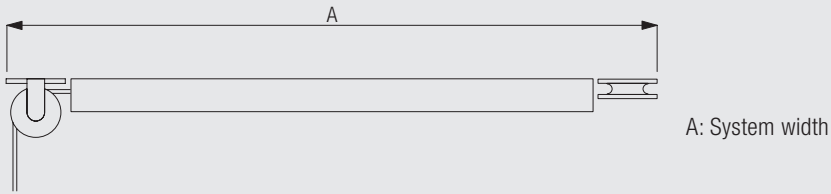

System Dimensions



20 m



95 kg

Max. Curtain Weight Chart

5850

	4 m	8 m	12 m	16 m	20 m
	85	80	70	60	50
	95	90	80	70	60
	50	45	40	35	-
	60	55	50	45	-
	40	35	30	-	-
	45	40	35	-	-
	65	60	50	-	-
	75	70	60	-	-

(kg max.)

Fixing Points

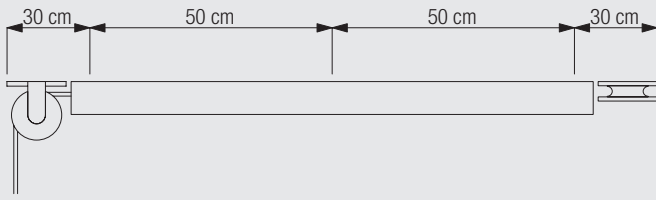

Fitting Options

CAD download through Silent Gliss Extranet / Downloads

Ceiling fitting with clamp 6209

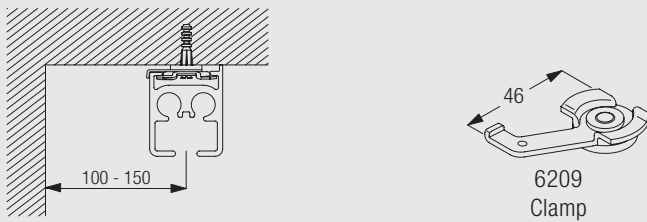

The final distances from the wall depend on curtain weight, make-up and any obstructions.

Ceiling fitting with clamp 6209 (double track)

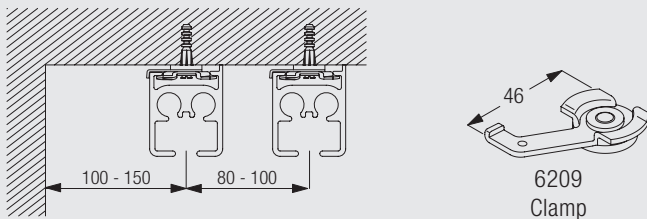

The final distances from the wall depend on curtain weight, make-up and any obstructions.



5850

Standard Accessories

3581	Hook		5809	Roller	
5811	Overlap arm		5815	Cord guide return	
5816	Cord guide		5824	Endstop	

Useful Measurements

5830 Cord crank

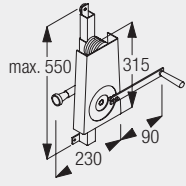

6575 Cord tensioner

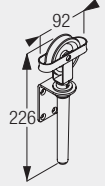

6578 Floor plate



5850



5850

www.silentgliss.at
www.silentgliss-russia.com
www.silentgliss-cee.com

Silent Gliss GesmbH
Gewerbestraße 6
A - 6710 Nenzing
Tel. + 43 (0) 5525 64 111
Fax. + 43 (0) 5525 63 170

Silent Gliss GesmbH
Jochen-Rindt-Straße 1
A - 1230 Wien
Tel. + 43 (0) 1 615 02 72
Fax. + 43 (0) 1 615 02 72-88

Silent Gliss GesmbH
Vertriebsbüro / Showroom
Stubenring 6
A – 1010 Wien
Tel. +43 (0) 1 513 16 77
Fax. +43 (0) 1 513 16 77-88