

Cord Operated Curtain Track Systems

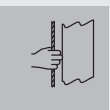



Cord Operated Curtain Track System

Silent Gliss® 6370

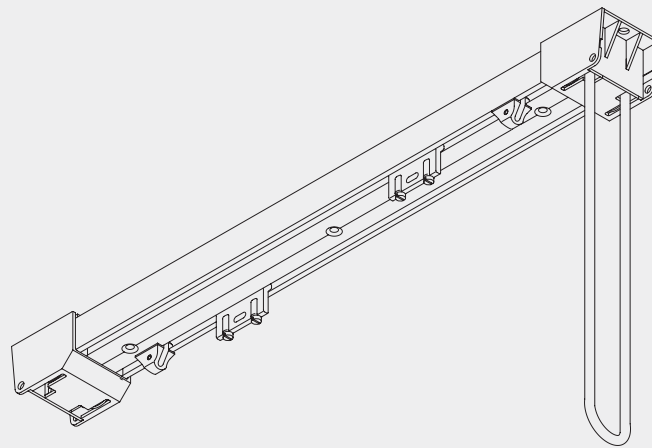

Product Information

- Curtain track system with twin channel for heavy applications like small stages, conference rooms and very heavy contract and residential use.
- Thanks to the twin-channel an overlap is guaranteed.
- The maximum size of the system depends on fabric weight.
- For horizontal, straight and bent applications with single, double or multiple symmetrical stacks.
- Standard colours: anodised aluminium or white powder coated.
- Standard length of the profiles is 6 m.
- Simple direct to the ceiling fixing (through profile).
- Delivered ready assembled. Large and attractive fabric offer.



6370

Profile and Bending Information

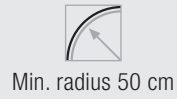
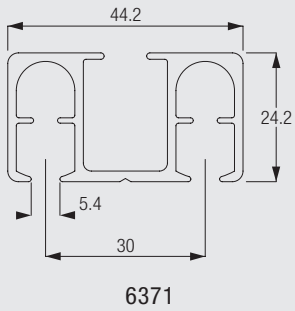

How to measure

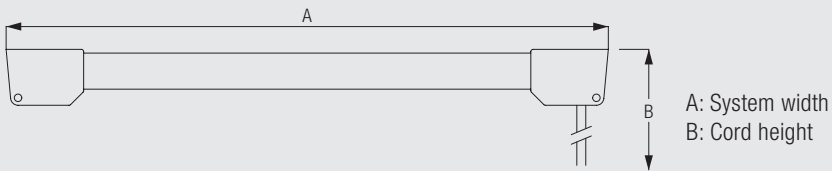

System Dimensions



15 m



70 kg

Max. Curtain Weight Chart (with rollers)



	3 m	6 m	9 m	12 m	15 m
	65	60	55	50	45
	70	65	60	55	50
	48	42	36	31	26
	54	48	42	36	30
	38	32	27	22	18
	44	38	32	27	22
	24	15	5	-	-
	27	19	10	-	-
	(kg max.)				

Fixing Points

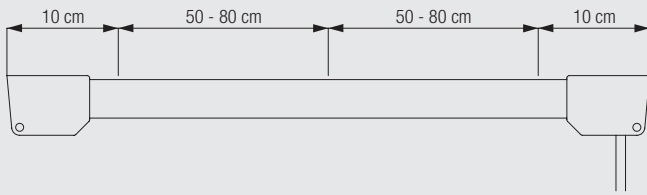

Fitting Options

CAD download through Silent Gliss Extranet / Downloads

Direct to ceiling fitting through profile

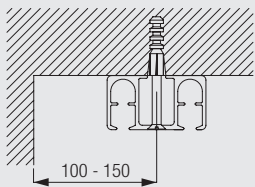

The final distances from the wall depend on curtain weight, make-up and any obstructions.

Recess fitting through profile

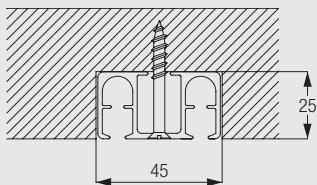

The final distances from the wall depend on curtain weight, make-up and any obstructions.

Wall fitting with bracket 3239 and Nut 6369

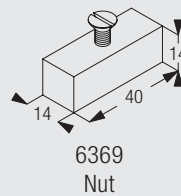
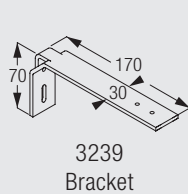
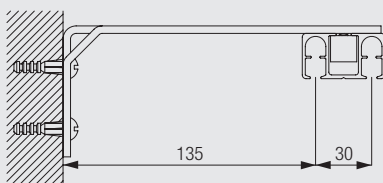

6370

Standard Accessories

3581 Hook



6086 Spring stop



6098 Roller



Optional Accessories

3599 Hook



5830 Cord crank



6283 Roller



Useful Measurements

6372 Connecting bridge

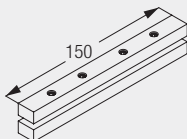

6575 Cord tensioner



6578 Floor plate



6370



www.silentgliss.at
www.silentgliss-russia.com
www.silentgliss-cee.com

Silent Gliss GesmbH
Gewerbestraße 6
A - 6710 Nenzing
Tel. + 43 (0) 5525 64 111
Fax. + 43 (0) 5525 63 170

Silent Gliss GesmbH
Jochen-Rindt-Straße 1
A - 1230 Wien
Tel. + 43 (0) 1 615 02 72
Fax. + 43 (0) 1 615 02 72-88

Silent Gliss GesmbH
Vertriebsbüro / Showroom
Stubenring 6
A – 1010 Wien
Tel. +43 (0) 1 513 16 77
Fax. +43 (0) 1 513 16 77-88