

# Hand Operated Curtain Track Systems





## Hand Operated Curtain Track System

# Silent Gliss® 1011

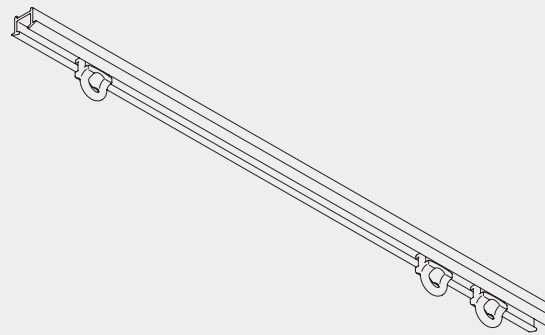

### Product Information

- Hand operated curtain track for light curtains in residential applications.
- Thin, elegant and bendable recess profile for timber ceilings. Pre-drilled every 30 mm.
- Standard colours: anodised aluminium or white powder coated.
- System is designed for recess fixing.
- Standard length of the profiles is 6 m. Systems can be planned to unlimited lengths due to a special connecting bridge.
- Large and attractive fabric offer.



1011

## Profile and Bending Information

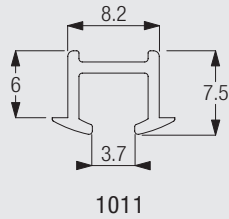

## Fitting Information

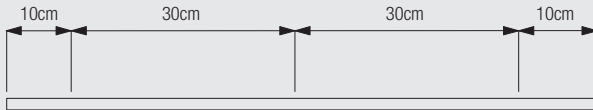

Silent Gliss tools for fast and efficient fitting.

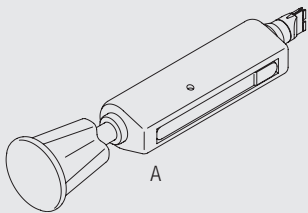

- A: Center 7550 tool
- B: Screw 3019 / 12 mm
- C: Screw 3025 / 18 mm

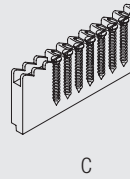
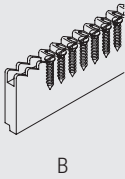
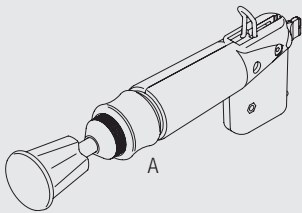

- A: Centomat 7200 tool
- B: Magazine 3412 of 50 screws 3019 / 12 mm
- C: Magazine 3418 of 50 screws 3025 / 18 mm

1011

## Fitting Options

CAD download through Silent Gliss Extranet / Downloads

### Recess Fitting in timber with single profile

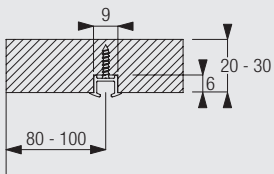

The final distances from the wall depend on curtain weight, make-up and any obstructions.

## Recess Fitting in timber with two or multiple profiles

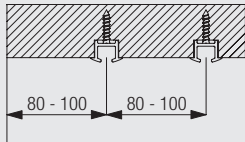

The final distances depend on curtain weight, make-up and any obstructions.

### Standard Accessories

3070 End stop



3085 Spring stop



3533 Glider



3599 Hook



### Optional Accessories

3534 Glider 3533 in strip form



3537 Glider



3548 Clic-glider



3549 Clic-hookglider



3582 Hook



3598 Eyelet



### Useful Measurements

3063 Connecting bridge

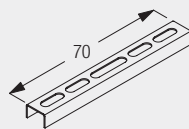

1011



1011



1011

[www.silentgliss.at](http://www.silentgliss.at)  
[www.silentgliss-russia.com](http://www.silentgliss-russia.com)  
[www.silentgliss-cee.com](http://www.silentgliss-cee.com)

Silent Gliss GesmbH  
Gewerbestraße 6  
A - 6710 Nenzing  
Tel. + 43 (0) 5525 64 111  
Fax. + 43 (0) 5525 63 170

Silent Gliss GesmbH  
Jochen-Rindt-Straße 1  
A - 1230 Wien  
Tel. + 43 (0) 1 615 02 72  
Fax. + 43 (0) 1 615 02 72-88

Silent Gliss GesmbH  
Vertriebsbüro / Showroom  
Stubenring 6  
A – 1010 Wien  
Tel. +43 (0) 1 513 16 77  
Fax. +43 (0) 1 513 16 77-88