

Hand Operated Curtain Track Systems

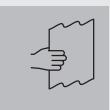



Hand Operated Curtain Track System

Silent Gliss® 1080

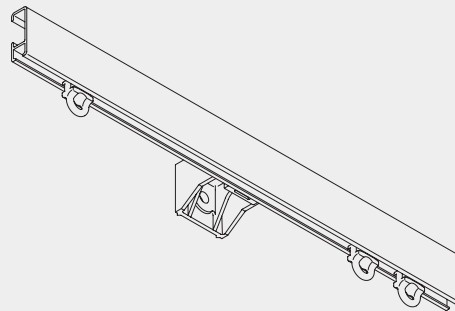

Product Information

- Universal and versatile hand operated curtain track for residential and contract applications.
- For light and medium weight curtains.
- Very elegant, sturdy and bendable profile with hidden fitting channel. Particularly suited for deep curtain headings.
- Easy ceiling or wall fixing or can be suspended from hanger rods.
- Wide variety of accessories for professional fitters.
- Standard colours: anodised aluminium or white powder coated.
- Standard length of the profiles is 6 m. Systems can be planned to unlimited lengths due to a special connecting bridge.
- Large and attractive fabric offer.



1080

Profile and Bending Information

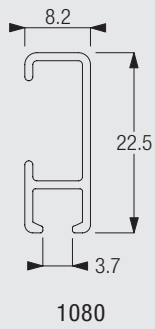

Fitting Information



Fitting Options

CAD download through Silent Gliss Extranet / Downloads

Ceiling fitting with bracket 3603

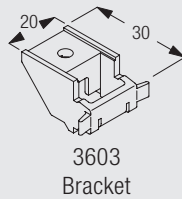
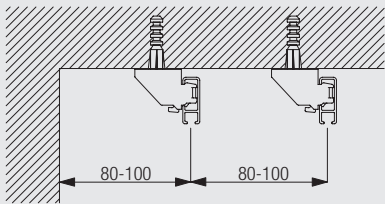

The final distances from the wall depend on curtain weight, make-up and any obstructions.

Ceiling fitting with bracket 3603 and bracket arms 3272 - 3274

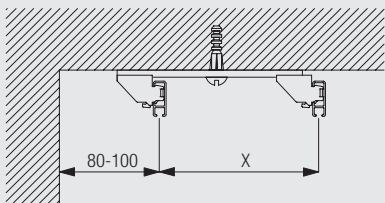

	X (mm)
3272	52
3273	75
3274	105

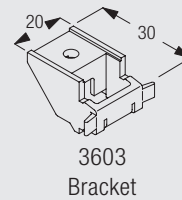
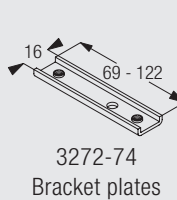

The final distances from the wall depend on curtain weight, make-up and any obstructions.

1080

Suspended fitting with bracket 3603 and hanger rod system 3639

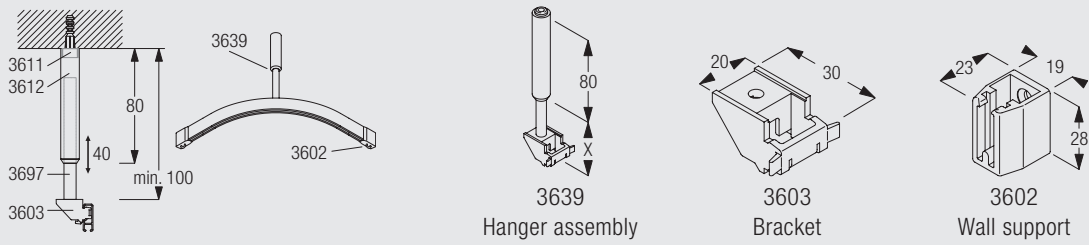

The final distances from the wall depend on curtain weight, make-up and any obstructions.

Wall fitting with universal brackets 3630/3655/3660

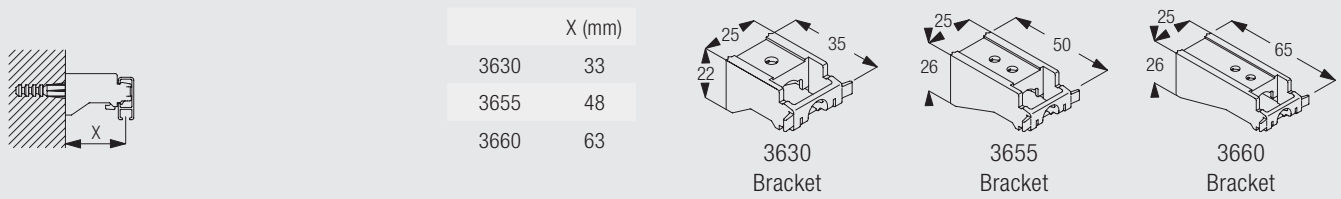

Wall fitting with brackets 3134-39 and bracket 3603

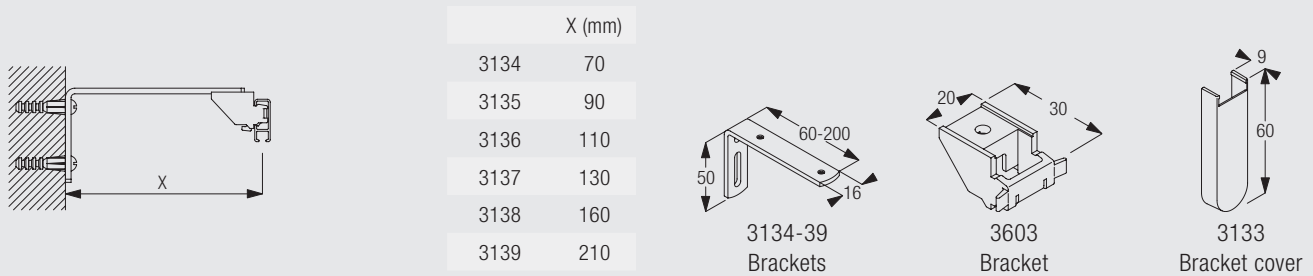

Wall fitting with adjustable bracket support 3271 / bracket plates 3272-74 and bracket 3603

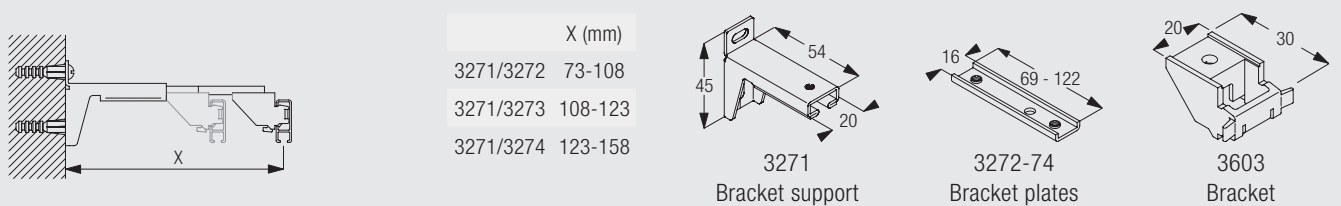

Standard Accessories

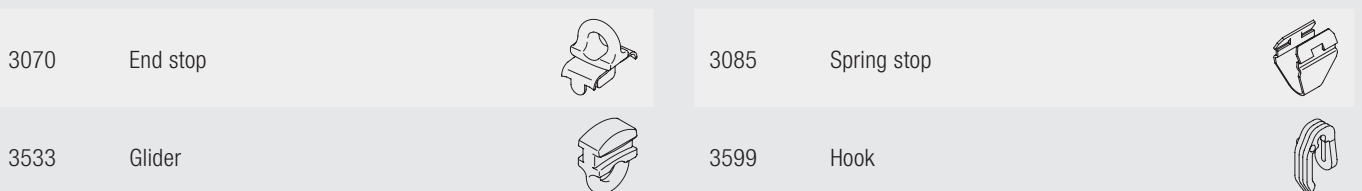

Optional Accessories

3534 Glider 3533 in strip form



3537 Glider



3548 Clic-glider



3549 Clic-hookglider



3581 Hook



3582 Hook



3598 Eyelet



6146 Hook (for shower curtains with eyelets)



Useful Measurements

3605 End cover

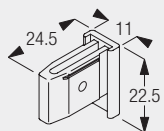

3618 Wall support

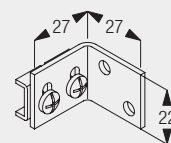

3620 Connecting bridge

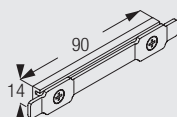

3638 Corner piece

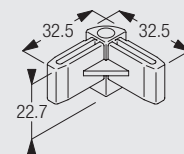

1080



1080

www.silentgliss.at
www.silentgliss-russia.com
www.silentgliss-cee.com

Silent Gliss GesmbH
Gewerbestraße 6
A - 6710 Nenzing
Tel. + 43 (0) 5525 64 111
Fax. + 43 (0) 5525 63 170

Silent Gliss GesmbH
Jochen-Rindt-Straße 1
A - 1230 Wien
Tel. + 43 (0) 1 615 02 72
Fax. + 43 (0) 1 615 02 72-88

Silent Gliss GesmbH
Vertriebsbüro / Showroom
Stubenring 6
A – 1010 Wien
Tel. +43 (0) 1 513 16 77
Fax. +43 (0) 1 513 16 77-88