

Venetian Blind Systems



 **SilentGliss**®



Venetian Blind System

Silent Gliss® 8100

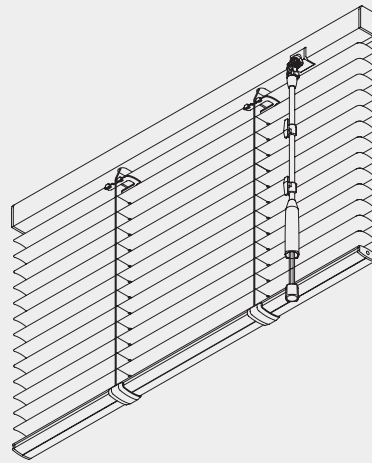

Product Information

- Venetian blind system for 16 mm aluminium slats.
- Unique user-friendly control wand, combining tilt operation of slats with integrated cords for fast raising/lowering of the blind.
- Left or right hand operation with various wand lengths available.
- Available in 77 different slat colours.
- The system can be used up to a maximum width of 2,5 m. The maximum system drop and surface are 2,5 m and 4 m².
- Can be equipped with side-guide wires and can therefore be used for sloped applications up to 15° inclination.
- The top stack of the slats can measure up to 12% of the blind drop (depending on slat widths and make-up). Please refer to the specific stack height charts.
- Beside fixation on window frame, this system can also be easily fitted with snap brackets on ceilings or walls.
- Delivered ready assembled.



8100

Profile Information

Profile for 16 mm Slats

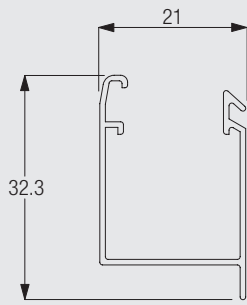

8101



Only for straight systems.

System Dimensions & Slat Stack Height



2,5 m



0,28 m



2,5 m



4 m²

Slat stack height calculation

		(cm)								
		50	75	100	125	150	175	200	225	250
16	X	6.1	7.0	7.9	8.8	9.7	10.6	11.5	12.4	13.3

8100

Please note that the indicated stack heights may vary by up to 1 cm.

System Options

Side guides for stabilising blind system and sloped applications (up to 15°)

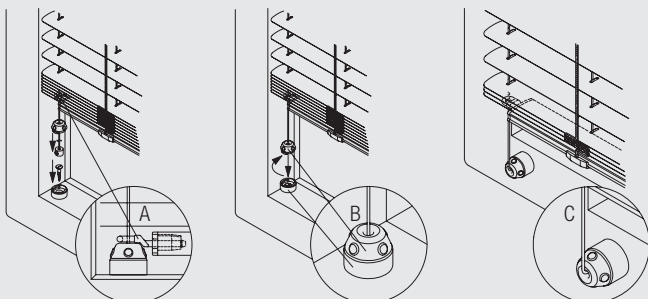

A and B: Fitting of side guides inside window frame
C: Fitting of side guides onto front of window frame

The system 8100 can be equipped with side-guide wires and can therefore also be used for sloped applications up to 15° inclination.

Fitting Information

Bracket Positioning

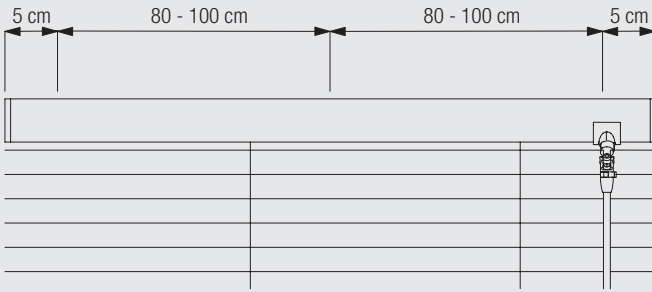

Side gaps when side-by-side fitting or recess fitting

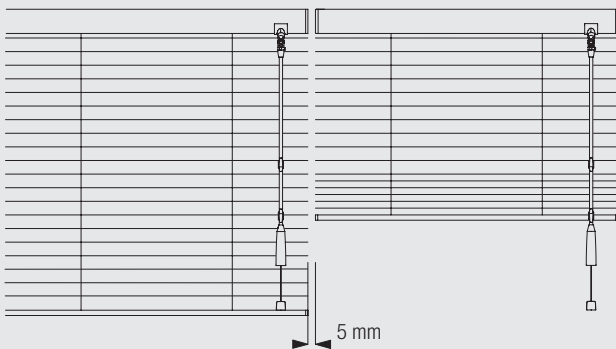

The light gap between two systems, when fitted side-by-side, has been minimized to only 5 mm.

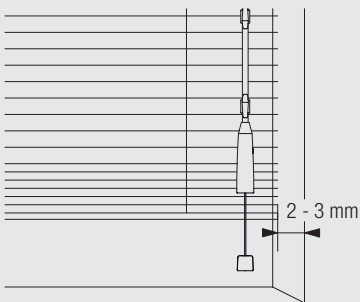

Distance from wall when recess fitting is 2-3 mm.



8100

Fitting Options

CAD download through Silent Gliss Extranet / Downloads

Ceiling fitting with bracket 8103 (16 mm)

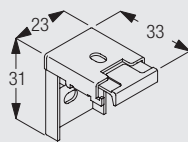
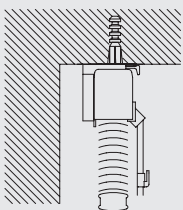

8103
Bracket (16 mm)

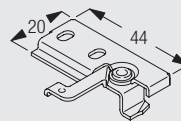

8149
Bracket

Wall- or window frame fitting with bracket 8103 (16 mm)

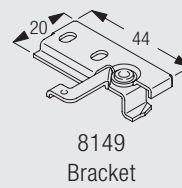
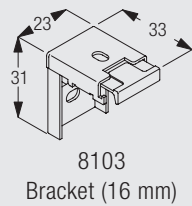
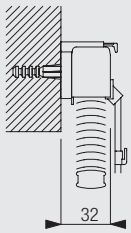

Optional: bracket 8149 for inside window frame fitting.

Wall fitting with brackets 3134-3135 and bracket 8103 (16 mm)

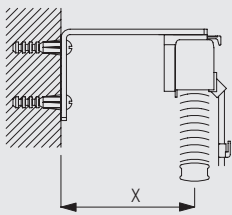

	x (mm)
3134	60
3135	80

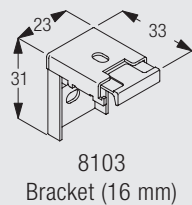
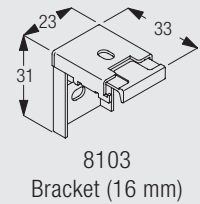
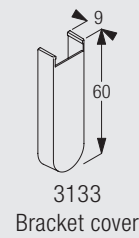
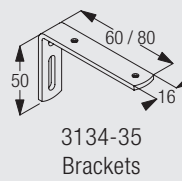

Wall fitting with adjustable bracket support 3271 / bracket plates 3272-73 and bracket 8103 (16 mm)

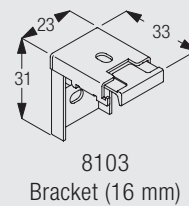
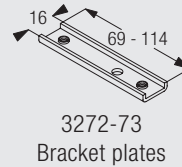
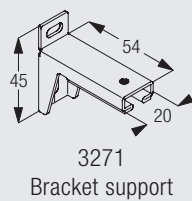
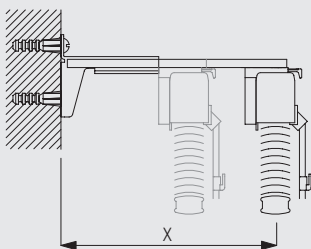

Wall fitting with bracket support 3271 and bracket 8103 (16 mm)

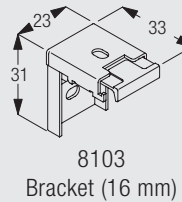
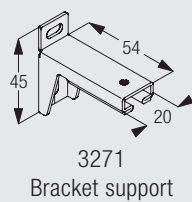
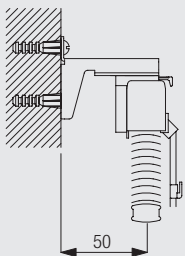



8100

www.silentgliss.at
www.silentgliss-russia.com
www.silentgliss-cee.com

Silent Gliss GesmbH
Gewerbestraße 6
A - 6710 Nenzing
Tel. + 43 (0) 5525 64 111
Fax. + 43 (0) 5525 63 170

Silent Gliss GesmbH
Jochen-Rindt-Straße 1
A - 1230 Wien
Tel. + 43 (0) 1 615 02 72
Fax. + 43 (0) 1 615 02 72-88

Silent Gliss GesmbH
Vertriebsbüro / Showroom
Stubenring 6
A – 1010 Wien
Tel. +43 (0) 1 513 16 77
Fax. +43 (0) 1 513 16 77-88