

Venetian Blind Systems



 **SilentGliss**[®]



Venetian Blind System

Silent Gliss® 8110

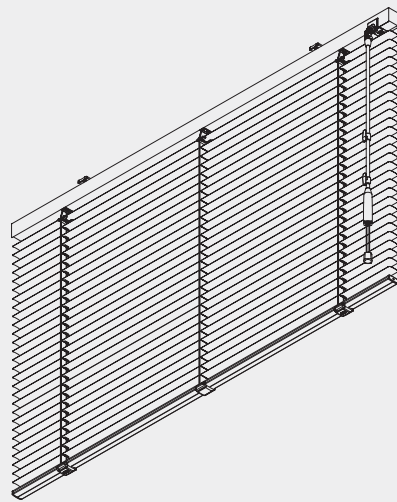

Product Information

- Venetian blind system for 16 mm or 25 mm aluminium slats.
- Unique user-friendly control wand, combining tilt operation of slats with integrated cords for fast raising/lowering of the blind.
- Left or right hand operation with various wand lengths available.
- Available in 77 different slat colours. Also perforated slats available for 25 mm slats.
- The system can be used up to a maximum width of 3,0 m (25 mm slats), respectively 2,5 m (16 mm slats). The maximum system drop and surface with 25 mm are 5,0 m and 7 m², respectively 2,5 m and 5 m² when using 16 mm slats.
- Can be equipped with side-guide wires and can therefore be used for sloped applications up to 15° inclination.
- The top stack of the slats can measure up to 12% of the blind drop (depending on slat widths and make-up). Please refer to the specific stack height charts.
- Beside fixation on window frame, this system can also be easily fitted with snap brackets on ceilings or walls.
- Special optional "privacy feature" (PC) available for 25 mm slats, where the slats are punched with a special method to ensure no direct light penetration when slats are closed.
- Delivered ready assembled.



8110

Profile Information

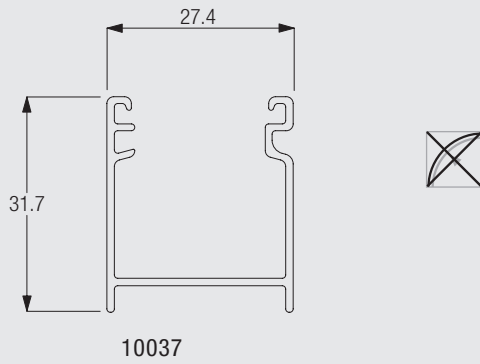

System Dimensions and Slat Stack Height



2,5 m (16 mm slats)
3,0 m (25 mm slats)



28 cm (16 and 25 mm slats)









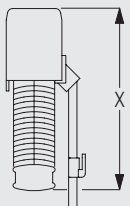

2,5 m (16 mm slats)
5,0 m (25 mm slats)

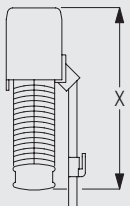

5 m² (16 mm slats)
7 m² (25 mm slats)

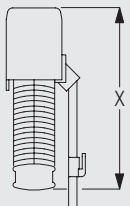
Slat stack height calculation

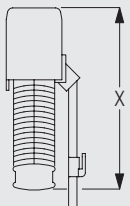
			 (cm)											
			50	75	100	125	150	175	200	225	250	275	300	325
		16	X	6.1	7.0	7.9	8.8	9.7	10.6	11.5	12.4	13.3		
		25 (PC)	X	6.4	7.3	8.1	9.1	9.6	10.6	11.5	12.3	13.2	14.0	15.0

			 (cm)								
			350	375	400	425	450	475	500		
		16	X								
		25 (PC)	X	16.7	17.6	18.4	19.3	20.2	21.0	21.9	

Please note that the indicated stack heights may vary by up to 1 cm.

System Options

“Privacy feature” (PC) available for 25 mm slats / Option

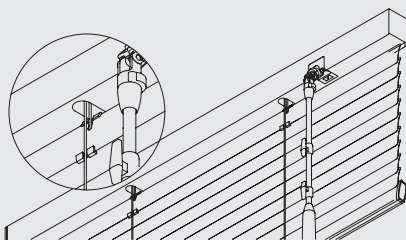

The slats are punched with a special method to ensure no direct light penetration when slats are closed. The PC feature on system 8110 is ideal for the use in offices and helps compliance with EC computer shading regulations.

Side guides for stabilising blind system and sloped applications (up to 15°)

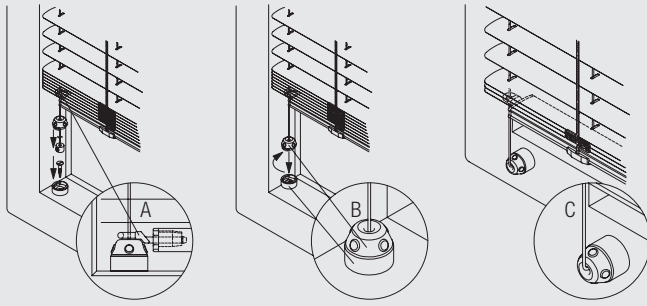

A and B: Fitting of side guides inside window frame (A: detail eyelet / B: detail wireholder)
C: Fitting of side guides onto front of window frame

The system 8110 can be equipped with side-guide wires and can therefore also be used for sloped applications up to 15° inclination.

Fitting Information

Bracket Positioning

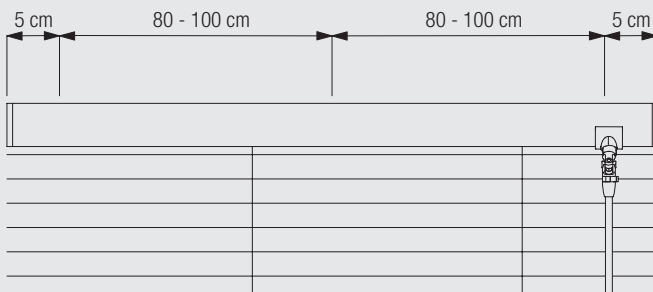

Side gaps when side-by-side fitting or recess fitting

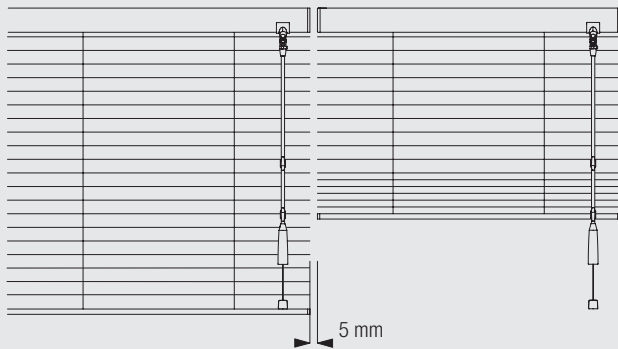

The light gap between two systems, when fitted side-by-side has been minimized to only 5 mm.

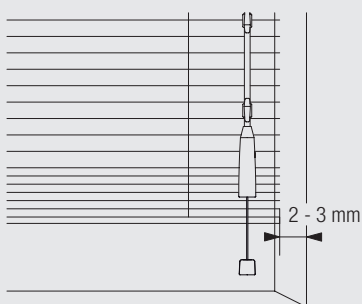

Distance from wall when recess fitting is 2-3 mm.



8110

Fitting Options

Ceiling fitting with bracket 10101

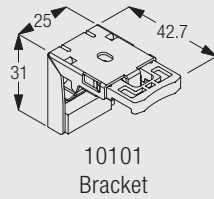
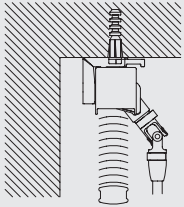

Recess fitting with bracket 10101

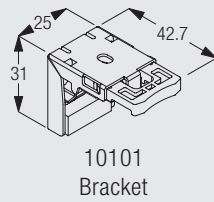
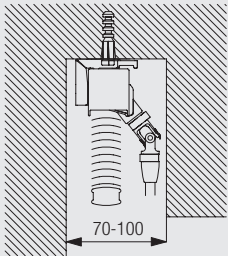

Wall or window frame fitting with bracket 10101

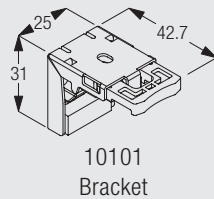
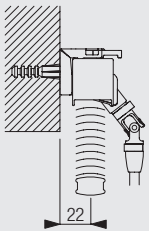

8110

Wall fitting with brackets 3134-35 and bracket 10101

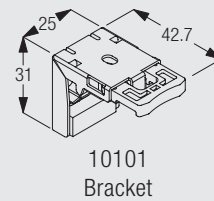
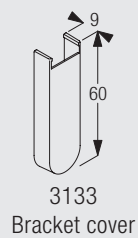
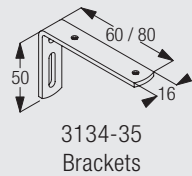
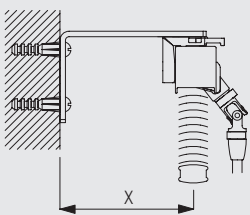

Wall fitting with adjustable bracket support 3271 / bracket plates 3272-73 and bracket 10101 (16 mm slats)

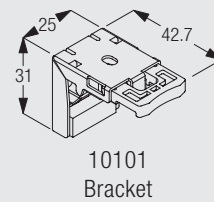
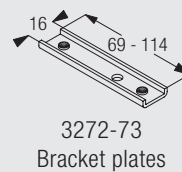
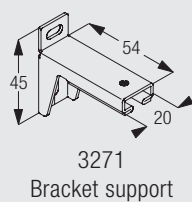
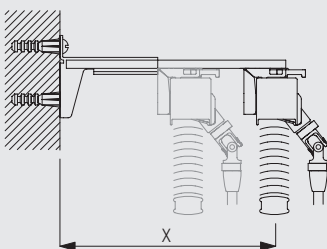

Wall fitting with bracket support 3271 and bracket 10101 (16 mm slats)

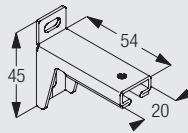
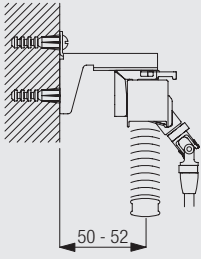

3271
Bracket support

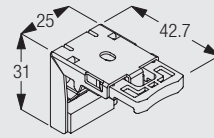

10101
Bracket



8110

www.silentgliss.at
www.silentgliss-russia.com
www.silentgliss-cee.com

Silent Gliss GesmbH
Gewerbestraße 6
A - 6710 Nenzing
Tel. + 43 (0) 5525 64 111
Fax. + 43 (0) 5525 63 170

Silent Gliss GesmbH
Jochen-Rindt-Straße 1
A - 1230 Wien
Tel. + 43 (0) 1 615 02 72
Fax. + 43 (0) 1 615 02 72-88

Silent Gliss GesmbH
Vertriebsbüro / Showroom
Stubenring 6
A – 1010 Wien
Tel. +43 (0) 1 513 16 77
Fax. +43 (0) 1 513 16 77-88